

OBZOR

switches & outlets

**technical
catalogue**

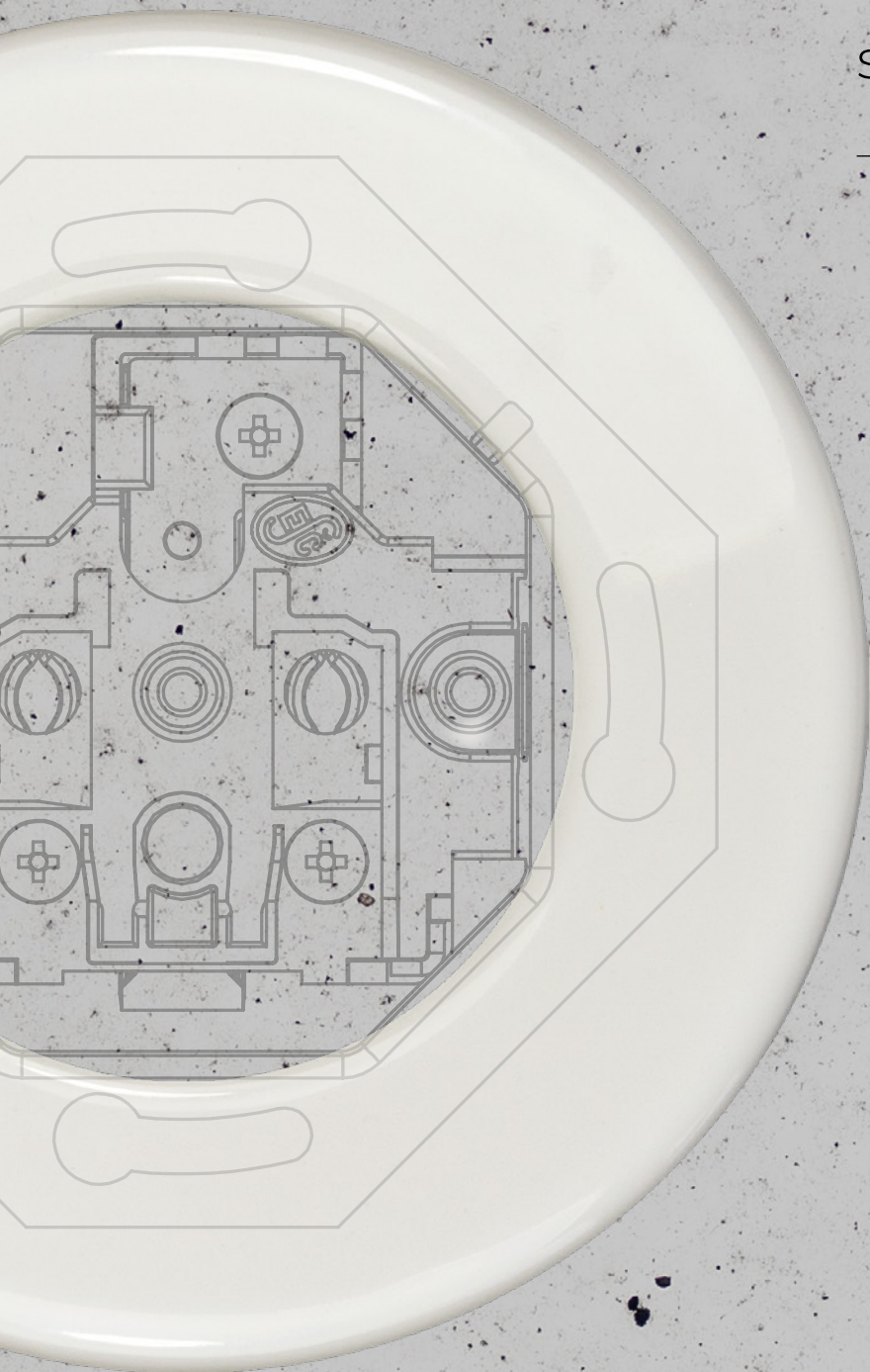

O3ZOR

switches & outlets
made in Czech Republic

content

about us	4
nexa	9
retro	17
decente	31
accessories	40
decente hotel systems	42
decente smart home	44
elegant	47
accessories	58
elegant aqua IP 44	61
elegant vacuum outlets	63
elegant medical	65
thermostats and motion sensors	69
wiring diagrams.....	72
technical drawings	74

obzor

... tradition since 1965

OBZOR company was founded almost sixty years ago. During this time the company has established among the top manufacturers and distributors of small electromechanical products, automotive parts, metal and injection moulding parts. Year 2000 can be considered as the beginning of development and subsequent production of wiring products such as switches, outlets, drivers and more.

- a company of tradition 100% Czech owned
- stability and quality
- traditional Czech manufacturer of cam switches, house wiring and accessories
- major supplier of plastic parts for automotive
- top equipment
- assembly of products
- socially responsible company



product lines

elegant / since 2003

A product line of classic, unobtrusive design that offers wide range of colours and combinations. Unique frame design, which allows to combine two colours together - on the side and base frame segment. An unusual design for joining frames can also create vertical, modular or up to seven times horizontal combinations.

- product features**
- switches, outlets, controllers
 - aqua outlets and switches with IP 44 protection
 - medical series outlets for healthcare industry
 - vacuum outlets
 - thermostats, PIR sensors
 - short-press switches for smart home systems

decente / since 2011

This timeless product line uses natural noble materials – glass, wood, metal, concrete and plexiglass. These prime frames can be combined up to four-fold horizontal and vertical. In 2014–2015, Decente range has expanded with new glass frame colours, matt frames, and more affordable PLEXIGLASS version in white or black.

- product features**
- switches, outlets, controllers
 - thermostats, PIR sensors
 - short-press switches for smart home systems
 - data outlets
 - DECENTE hotel systems

retro / since 2017

Switches of RETRO line feature an original design inspired by rotary switches from the 1930s and unique functionalist architecture of Zlín city. Round frames are made of solid wood, ceramics, glass or concrete and are also available in horizontal / vertical double or triple versions. Switches are unusually controlled by a handle. They are suitable not only for rustic, but also for minimalist and industrial interiors. RETRO series contains wide range of fittings according to current standards for a comfortable living.

- product features**
- switches, outlets, controllers
 - data outlets
 - thermostats and motion sensors

nexa / since 2024

A new series that builds on the successful RETRO toggle switches. The biggest difference is the material used - timeless and always elegant glass in black and white. It also differs from the existing frames in size and strength frame. Compared to the original thickness of 13.5 millimetres, it is now only eight millimetres thick. For lovers of natural design lovers, the wood frames are available in maple and oak.

- product features**
- switches, outlets, controllers
 - data outlets

assembly of fittings

– composition of ordering code

In case of demand of a single frame set, fittings can be specified by a composite assembly code with following definition:

elegant

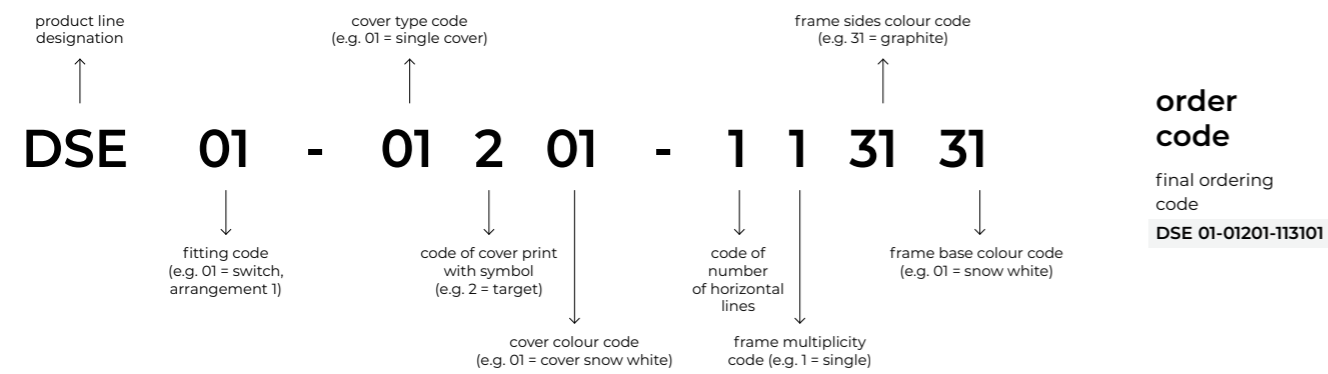
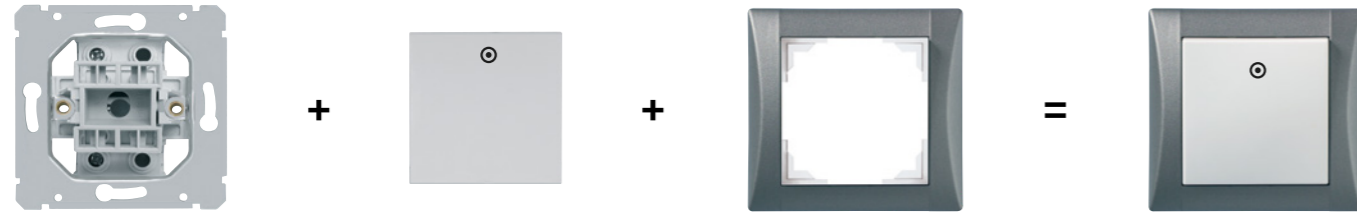

retro

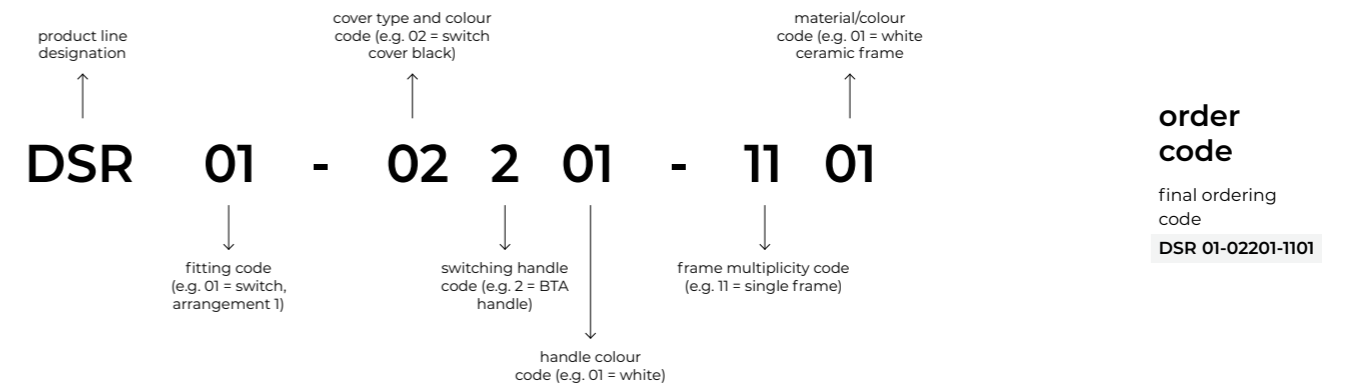

decente

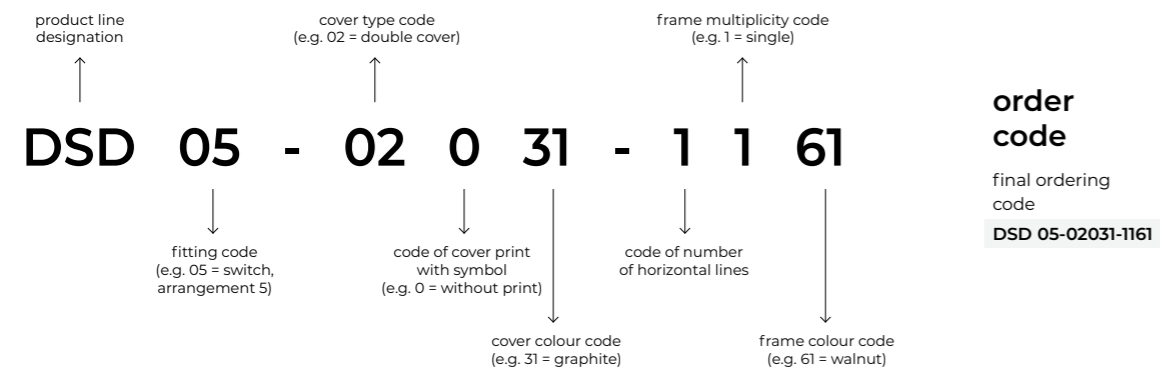
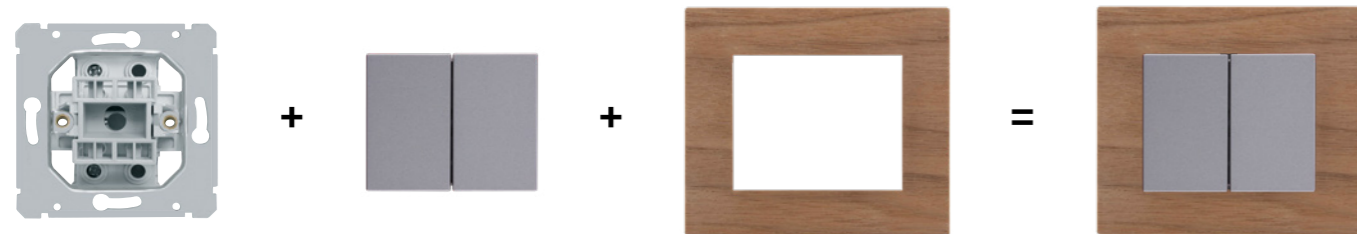

nexa

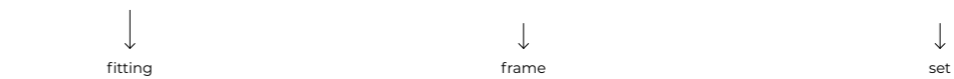
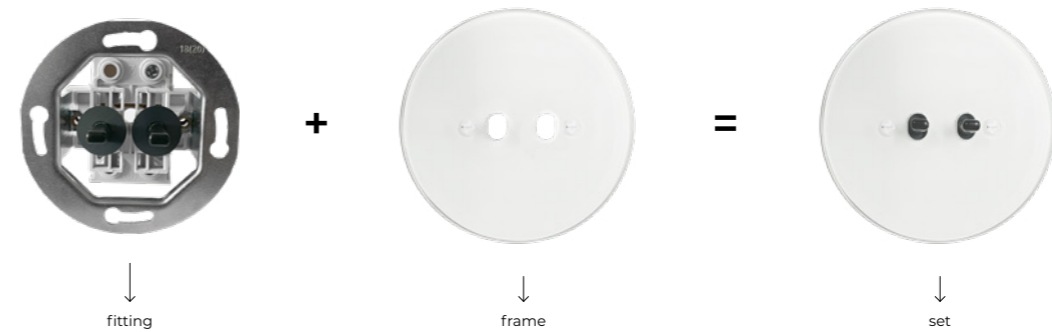

We'll be always glad to help you with your specification and order.
In case of any questions please do not hesitate to contact our sales department, tel.: +420 577 195 138 or e-mail: export@obzor.cz.



nexa

*minimalistic
design*



A new design series of switches and sockets inspired by the toggle RETRO series, presenting a perfect blend of minimalism and functionality in every space. The frame material includes high-quality glass in practical white and black finishes, as well as wooden frames for those seeking a natural design. Setting it apart from the RETRO series is the size and thickness of the frame, measuring 86 mm in diameter and 8 mm in thickness, providing modern and minimalist vibes to interiors.

glass

It is characterized by clean and simple shapes that emphasize the beauty of glass. Switches are designed with an emphasis on minimalist style and ergonomic design, giving the interior a modern look.



glass white frame
/ double toggle white



glass black frame
/ single toggle black



glass black frame
/ outlet cover black matt

wood

It combines the timeless natural beauty of wood with the modern appearance of metal. Each piece is carefully crafted to blend traditional craftsmanship with premium design, creating a unique spatial element.



wooden light oak frame
/ single toggle white



wooden dark stained oak frame
/ double toggle black



wooden maple frame
/ outlet cover white



sets



single toggle switch
(arrangement 1, 2, 6, 7, 1/0)



single toggle switch
(arrangement 5, 6+6, 1/0+1/0),
shutter switch



single outlet



schuko
single outlet



TV outlet, SAT, PC outlet
cat. 5E / cat.6



USB-A outlet
/ USB-A charging outlet



USB-C charging
outlet

frames

glass



wood **

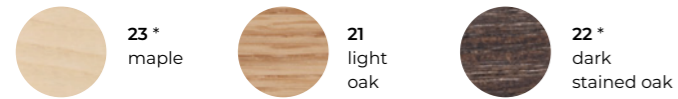

toggles

metal

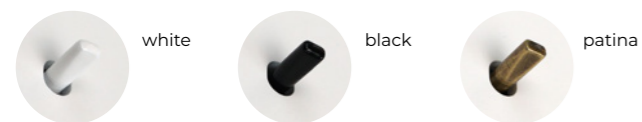

covers



01
white



02
black



34
black
matt

frame multiplicities

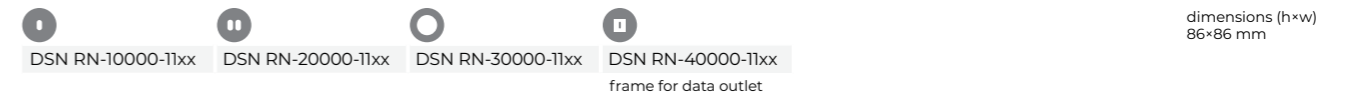

horizontal

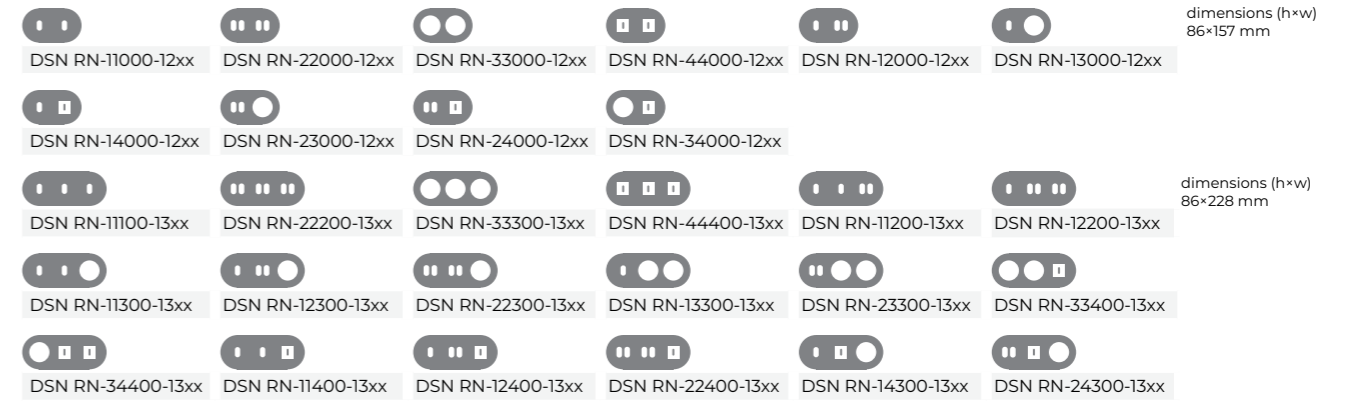

vertical

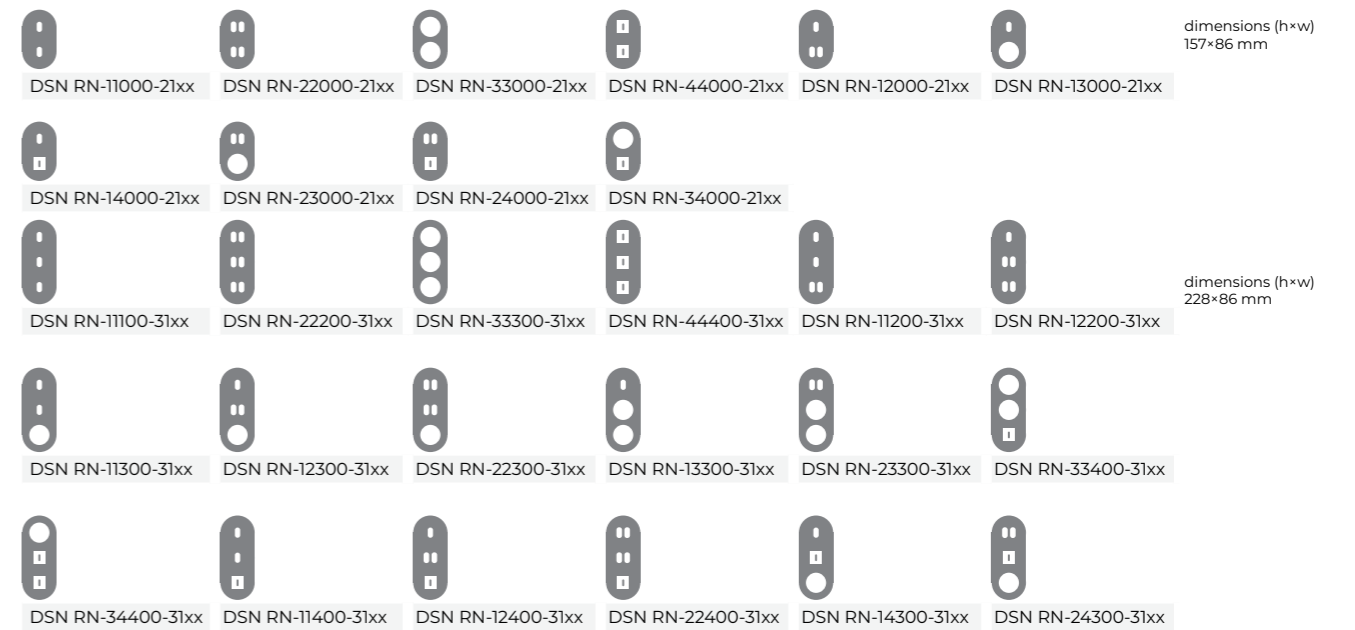

* Available by order only.
** For wooden frames we use only solid wood therefore each frame is unique and tone/pattern might slightly vary.

fittings / outlets

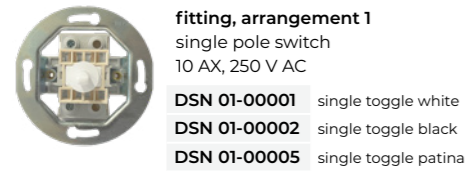

fitting, arrangement 1
single pole switch
10 AX, 250 V AC
DSN 01-00001 single toggle white
DSN 01-00002 single toggle black
DSN 01-00005 single toggle patina

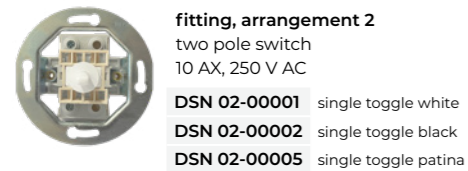

fitting, arrangement 2
two pole switch
10 AX, 250 V AC
DSN 02-00001 single toggle white
DSN 02-00002 single toggle black
DSN 02-00005 single toggle patina

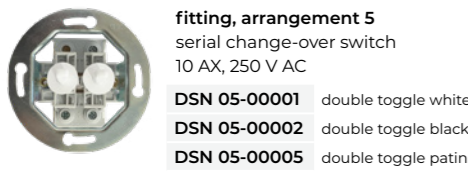

fitting, arrangement 5
serial change-over switch
10 AX, 250 V AC
DSN 05-00001 double toggle white
DSN 05-00002 double toggle black
DSN 05-00005 double toggle patina

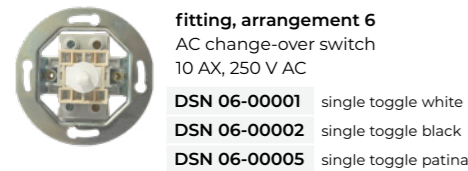

fitting, arrangement 6
AC change-over switch
10 AX, 250 V AC
DSN 06-00001 single toggle white
DSN 06-00002 single toggle black
DSN 06-00005 single toggle patina

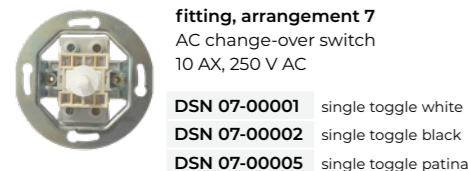

fitting, arrangement 7
AC change-over switch
10 AX, 250 V AC
DSN 07-00001 single toggle white
DSN 07-00002 single toggle black
DSN 07-00005 single toggle patina

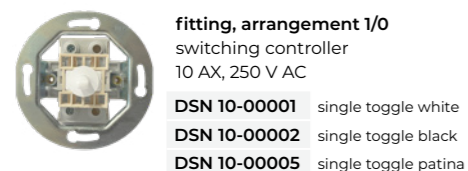

fitting, arrangement 1/0
switching controller
10 AX, 250 V AC
DSN 10-00001 single toggle white
DSN 10-00002 single toggle black
DSN 10-00005 single toggle patina

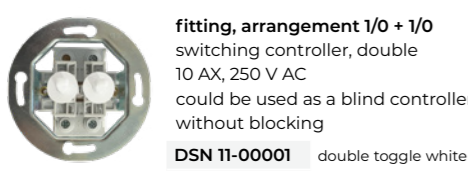

fitting, arrangement 1/0 + 1/0
switching controller, double
10 AX, 250 V AC
could be used as a blind controller
without blocking
DSN 11-00001 double toggle white
DSN 11-00002 double toggle black
DSN 11-00005 double toggle patina

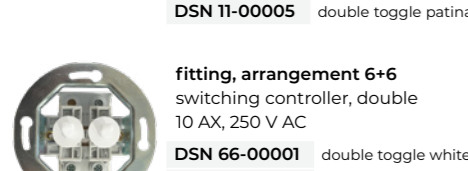

fitting, arrangement 6+6
switching controller, double
10 AX, 250 V AC
DSN 66-00001 double toggle white
DSN 66-00002 double toggle black
DSN 66-00005 double toggle patina

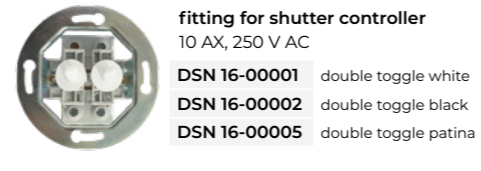

fitting for shutter controller
10 AX, 250 V AC
DSN 16-00001 double toggle white
DSN 16-00002 double toggle black
DSN 16-00005 double toggle patina

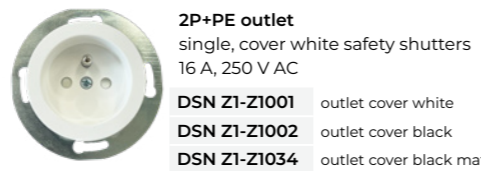

2P+PE outlet
single, cover white safety shutters
16 A, 250 V AC
DSN Z1-Z1001 outlet cover white
DSN Z1-Z1002 outlet cover black
DSN Z1-Z1034 outlet cover black matt

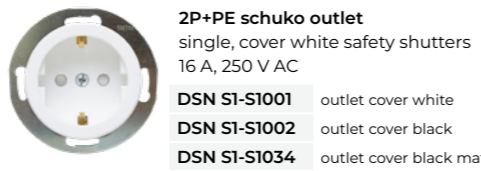

2P+PE schuko outlet
single, cover white safety shutters
16 A, 250 V AC
DSN S1-S1001 outlet cover white
DSN S1-S1002 outlet cover black
DSN S1-S1034 outlet cover black matt

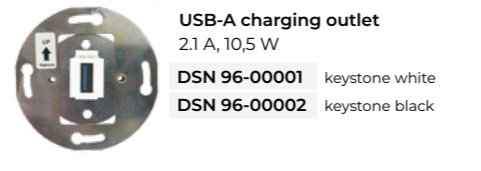

USB-A charging outlet
2.1 A, 10,5 W
DSN 96-00001 keystone white
DSN 96-00002 keystone black



USB-C charging outlet
2.1 A, 10,5 W
DSN 9C-00001 keystone white
DSN 9C-00002 keystone black

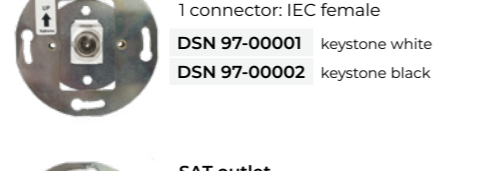

TV outlet
1 connector: IEC female
DSN 97-00001 keystone white
DSN 97-00002 keystone black

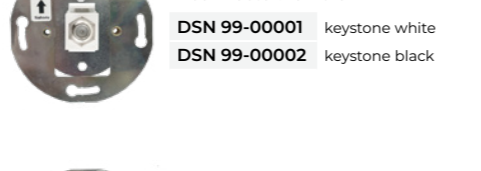

SAT outlet
1 connector: female
DSN 99-00001 keystone white
DSN 99-00002 keystone black



PC Cat. 5E outlet
1 connector: RJ 45 cat. 5E, UTP
DSN 93-00001 keystone white
DSN 93-00002 keystone black



PC Cat. 6 outlet
1 connector: RJ 45 cat. 6, UTP
DSN 98-00001 keystone white
DSN 98-00002 keystone black





retro

*tradition in
a modern design*



The range of RETRO switches and outlets is introducing an original design inspired by combination of rotary ceramic switches from the time of 1930 ´s and world-unique functionalist architecture of Zlin city, where OBZOR comes from. Therefore RETRO line finds its place not only in rustic, vintage, but also in modern loft, minimalist and industrial interiors.



A few clever interior complements, such as switches and outlets, will add to your interior's charm. Our RETRO switch is not just an unobtrusive device that fulfils its essential purpose but is equivalent design companion to the rest of household equipment.

Let us introduce you switches that are everything but discreet. No lines, edges or restraint in dimensions. RETRO switches are round, relatively massive and controlled by a rotary handle.

RETRO switches excel in modern lofts and other minimalist interiors. They will fit well on revealed brick walls, concrete walls as well as on ceramic tiles. RETRO will embellish also rustic interior, e.g. in rural chalets.

RETRO line offers usual range of fittings according to present-day requirements for comfortable living:

- various switching fittings
- shutter controller
- classic outlet (schuko version available)
- computer outlet
- TV outlet
- SAT outlet
- HDMI outlet
- USB charging outlet
- thermostats and motion sensors

There are four collections of noble natural materials to choose from:

- glass
- ceramics
- solid wood

glass collection

Design that is not ostentatious or complicated, but simply great. Design that brings up the beauty of the material, real glass. Timeless switches from this collection will highlight modern furnished interiors as well as masterpieces of modern architecture.



glass white frame
/ OBZ handle patina



glass black frame
/ BTA handle white



glass white frame
/ outlet cover black matt



DO YOU WANT TO
KNOW MORE?
www.retrovypinac.cz/en





ceramic collection

Here we combine white and black ceramic frames and covers. In case of switches you can choose from three different types of control handles that will bring up fresh and exciting combinations!



ceramic white frame / cover white
/ OBZ handle patina



ceramic black frame / cover white
/ single toggle black



ceramic black frame / cover black
/ BTA handle white

hand painted collection

Hand painted white ceramic collection offers single frames in four folklore patterns. These can be combined with any of our covers and handles / toggles.



pattern 1 / cover white
/ double toggle white



pattern 2 / cover white
/ ZLN handle patina



pattern 3 / cover white
/ OBZ handle patina



wood collection

In this collection we present solid wood frames where you can choose between light oak, dark stained oak and maple in combination with white or cover black.



wooden maple frame / cover white / BTA handle patina



wooden light oak frame / cover black / single toggle white



wooden dark stained oak frame / cover white / double toggle black

frames

glass



wood **

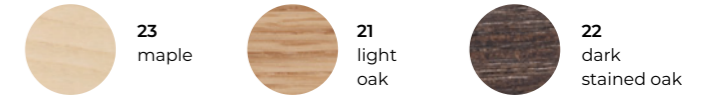

ceramic ***

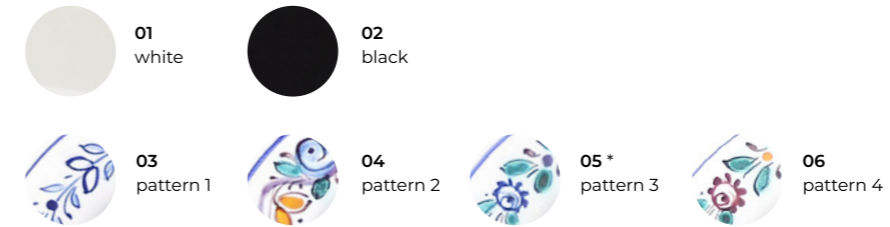





* Until stocks are sold out
 ** For wooden frames we use only solid wood therefore each frame is unique and tone/pattern might slightly vary.
 *** The painted RETRO frames are available by order only.



ORDER CODE:
 DSR 00-00000-11XX

frame multiplicities

	DSR 00-00000-11XX	dimensions (h*w) 97*97 mm all collections
	DSR 00-00000-12XX	dimensions (h*w) 97*168 mm ceramic (not painted), wood, glass
	DSR 00-00000-13XX	dimensions (h*w) 97*239 mm ceramic (not painted), wood
	DSR 00-00000-14XX	dimensions (h*w) 97*310 mm wood



Fittings and outlets can be combined within up to fourfold frame wall mounted in horizontal or vertical position. Same frame can be used for both options.

sets



switch arrangement
1, 2, 5, 6, 7, 1/0,
shutter switch



switch (glass) arrangement
1, 2, 5, 6, 7, 1/0,
shutter switch



single toggle switch
arrangement 1, 2, 6, 7, 1/0
press button up to 24 V



double toggle switch
arrangement 5, 6+6, 1/0 + 1/0
shutter switch
press button up to 24 V



LED dimmer



USB-A outlet
/ USB-A charging outlet



HDMI outlet



USB-C charging outlet



PC outlet
Cat. 5E / Cat. 6



TV outlet



SAT outlet



single outlet



schuko
single outlet



thermostat
(available only in wooden
and glass frames)



motion sensor
(available only in wooden
and glass frames)



For RETRO series switches, a long-proven cam switch mechanism is used.



Toggle switches use a rocker mechanism.



covers



switch cover white
+ white BTA handle
DSR 00-01201-0000



switch cover black
+ white BTA handle
DSR 00-02201-0000



HDMI, USB, TV, SAT
outlet cover, white
DSR 00-91000-0000



switch cover white
+ black BTA handle
DSR 00-01202-0000



switch cover black
+ black BTA handle
DSR 00-02202-0000

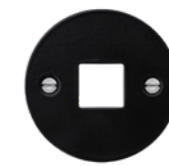

HDMI, USB, TV, SAT
outlet cover, black
DSR 00-92000-0000



switch cover white
+ patina BTA handle
DSR 00-01203-0000



switch cover black
+ patina BTA handle
DSR 00-02203-0000



PC outlet cover,
white
DSR 00-93000-0000



switch cover white
+ patina OBZ handle
DSR 00-01103-0000



switch cover black
+ patina OBZ handle
DSR 00-02103-0000



PC outlet cover,
black
DSR 00-94000-0000



switch cover white
+ patina ZLN handle
DSR 00-01303-0000



switch cover black
+ patina ZLN handle
DSR 00-02303-0000



outlet cover,
white
DSR 00-Z1000-0000



cover for a LED dimmer
rotary button
DSR 00-03401-0000



cover for a LED dimmer
rotary button
DSR 00-03434-0000



outlet cover,
black matt
DSR 00-Z2000-0000



cover for a LED dimmer
rotary button
DSR 00-04401-0000



cover for a LED dimmer rotary
button black/black mat
DSR 00-04434-0000



schuko outlet cover,
white
DSR 00-S3000-0000



blind cover
white
DSR 60-61000-0000



blind cover
black
DSR 60-62000-0000



schuko outlet cover,
black matt
DSR 00-S4000-0000



Switch covers and communication outlets cannot be used for RETRO glass collection. You can find covers for RETRO glass on page 29.



Switch covers come with screws supplied in pair in both silver and gold so you can choose which one fits better in your project.

fittings / outlets



fitting, arrangement 1
singlepole switch
16 AX, 250 V AC
DSR 01-00000-0000

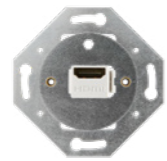

HDMI outlet
1 connector: HDMI female
DSR 92-00000-0000



2P+PE outlet
single, cover white safety shutters
16 A, 250 V AC
DSR Z1-Z1000-0000



fitting, arrangement 2
twopole switch
16 AX, 250 V AC
DSR 02-00000-0000

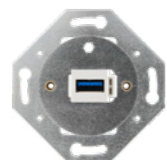

USB-A outlet
1 connector: USB 3.0 female
DSR 94-00000-0000



2P+PE outlet
single, black matt cover safety shutters
16 A, 250 V AC
DSR Z1-Z2000-0000



fitting, arrangement 5
serial change-over switch
16 AX, 250 V AC
DSR 05-00000-0000

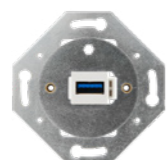

USB-A charging outlet
1 connector: USB 3.0 female + charger (2100 mA)
DSR 95-00000-0000



2P+PE schuko outlet
single, cover white safety shutters
16 A, 250 V AC
DSR S2-S3000-0000



fitting, arrangement 6
AC change-over switch
16 AX, 250 V AC
DSR 06-00000-0000

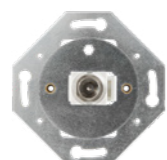

TV outlet
1 connector: IEC female
DSR 97-00000-0000

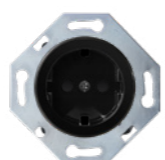

2P+PE schuko outlet
single, black matt cover safety shutters
16 A, 250 V AC
DSR S2-S4000-0000



fitting, arrangement 7
crossbar switch
16 AX, 250 V AC
DSR 07-00000-0000

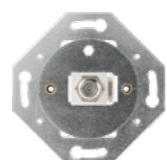

SAT outlet
1 connector: female
DSR 99-00000-0000



blind cover
DSR 60-61000-0000



fitting, arrangement 1/0
switching controller
16 AX, 250 V AC
DSR 10-00000-0000

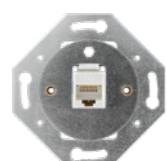

PC Cat. 5E outlet
1 connector: RJ45 Cat. 5E UTP
DSR 93-00000-0000



blind cover
DSR 60-62000-0000



fitting for shutter controller
rotary
16 AX, 230 V AC
DSR 22-00000-0000

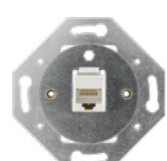

PC Cat. 6 outlet
1 connector: RJ45 Cat. 6 UTP
DSR 98-00000-0000



LED dimmer with arrangement 6
230 V AC, load 0-100 W LED, 10-250 W incandescent light bulb
DSR 23-00000-0000



3 gang 1 way switch
16 AX, 230V AC
DSR 03-00000-0000



USB-C charging outlet
1 connector: USB-C charger 2,1 A, 10,5 W
DSR 9C-00000-0000

fittings with covers & toggles



fitting, arrangement 1
single pole switch
10 AX, 250 V AC
DPR 01-01001-0000 cover white / single toggle white
DPR 01-01002-0000 cover white / single toggle black
DPR 01-01003-0000 cover white / single toggle patina
DPR 01-02001-0000 cover black / single toggle white
DPR 01-02002-0000 cover black / single toggle black
DPR 01-02003-0000 cover black / single toggle patina



press button 1/0, up to 24 V
50mA, 24 V DC
DPR 17-01001-0000 cover white / single toggle white
DPR 17-01002-0000 cover white / single toggle black
DPR 17-01003-0000 cover white / single toggle patina
DPR 17-02001-0000 cover black / single toggle white
DPR 17-02002-0000 cover black / single toggle black
DPR 17-02003-0000 cover black / single toggle patina



fitting, arrangement 2
two pole switch
10 AX, 250 V AC
DPR 02-01001-0000 cover white / single toggle white
DPR 02-01002-0000 cover white / single toggle black
DPR 02-01003-0000 cover white / single toggle patina
DPR 02-02001-0000 cover black / single toggle white
DPR 02-02002-0000 cover black / single toggle black
DPR 02-02003-0000 cover black / single toggle patina



fitting, arrangement 1/0 + 1/0
switching controller, double
10AX, 250 V AC
DPR 11-03001-0000 cover white / double toggle white
DPR 11-03002-0000 cover white / double toggle black
DPR 11-03003-0000 cover white / double toggle patina
DPR 11-04001-0000 cover black / double toggle white
DPR 11-04002-0000 cover black / double toggle black
DPR 11-04003-0000 cover black / double toggle patina



fitting, arrangement 5
serial change-over switch
10 AX, 250 V AC
DPR 05-03001-0000 cover white / double toggle white
DPR 05-03002-0000 cover white / double toggle black
DPR 05-03003-0000 cover white / double toggle patina
DPR 05-04001-0000 cover black / double toggle white
DPR 05-04002-0000 cover black / double toggle black
DPR 05-04003-0000 cover black / double toggle patina



fitting for shutter controller
10 AX, 250 V AC
DPR 16-03001-0000 cover white / double toggle white
DPR 16-03002-0000 cover white / double toggle black
DPR 16-03003-0000 cover white / double toggle patina
DPR 16-04001-0000 cover black / double toggle white
DPR 16-04002-0000 cover black / double toggle black
DPR 16-04003-0000 cover black / double toggle patina



fitting, arrangement 6
AC change-over switch
10 AX, 250 V AC
DPR 06-01001-0000 cover white / single toggle white
DPR 06-01002-0000 cover white / single toggle black
DPR 06-01003-0000 cover white / single toggle patina
DPR 06-02001-0000 cover black / single toggle white
DPR 06-02002-0000 cover black / single toggle black
DPR 06-02003-0000 cover black / single toggle patina



double press button 1/0+1/0, up to 24 V
50mA, 24 V DC
DPR 18-03001-0000 cover white / double toggle white
DPR 18-03002-0000 cover white / double toggle black
DPR 18-03003-0000 cover white / double toggle patina
DPR 18-04001-0000 cover black / double toggle white
DPR 18-04002-0000 cover black / double toggle black
DPR 18-04003-0000 cover black / double toggle patina



fitting, arrangement 7
crossbar switch
10 AX, 250 V AC
DPR 07-01001-0000 cover white / single toggle white
DPR 07-01002-0000 cover white / single toggle black
DPR 07-01003-0000 cover white / single toggle patina
DPR 07-02001-0000 cover black / single toggle white
DPR 07-02002-0000 cover black / single toggle black
DPR 07-02003-0000 cover black / single toggle patina



fitting, arrangement 6+6
double AC change-over switch
10 AX, 250 V AC
DPR 66-03001-0000 cover white / double toggle white
DPR 66-03002-0000 cover white / double toggle black
DPR 66-03003-0000 cover white / double toggle patina
DPR 66-04001-0000 cover black / double toggle white
DPR 66-04002-0000 cover black / double toggle black
DPR 66-04003-0000 cover black / double toggle patina



fitting, arrangement 1/0
switching controller
10 AX, 250 V AC
DPR 10-01001-0000 cover white / single toggle white
DPR 10-01002-0000 cover white / single toggle black
DPR 10-01003-0000 cover white / single toggle patina
DPR 10-02001-0000 cover black / single toggle white
DPR 10-02002-0000 cover black / single toggle black
DPR 10-02003-0000 cover black / single toggle patina

toggle colors / metal

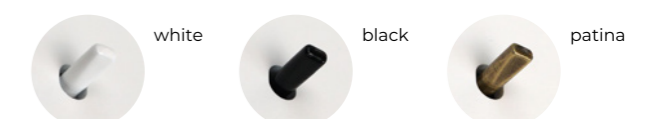

i **IMPORTANT:** Recommended min. depth of installation box for RETRO series is 60 mm. For more information, see the chapter Technical drawings or contact our sales department. Connectors for keystone outlets can also be supplied in black color.

i RETRO toggle switches are suitable for installation into standard installation boxes. For more information, see the chapter Technical drawings or contact our sales department. Toggle is always an integral part of the fitting and the cover is supplied with the device. Not for sale separately.

thermostats and motion sensors



EBERLE analogue ROOM thermostat under plaster mounting

- DSR 2T-00000-1130 white glass
- DSR 2T-00000-1131 black glass
- DSR 2T-00000-1121 light oak
- DSR 2T-00000-1122 dark stained oak
- DSR 2T-00000-1123 maple



EBERLE analogue FLOOR thermostat under plaster mounting, with sensor

- DSR 3T-00000-1130 white glass
- DSR 3T-00000-1131 black glass
- DSR 3T-00000-1121 light oak
- DSR 3T-00000-1122 dark stained oak
- DSR 3T-00000-1123 maple



digital thermostat EBERLE universal

- DSR 4T-00000-1130 white glass
- DSR 4T-00000-1131 black glass
- DSR 4T-00000-1121 light oak
- DSR 4T-00000-1122 dark stained oak
- DSR 4T-00000-1123 maple



move sensor B.E.G

- DSR BX-00000-1130 white glass
- DSR BX-00000-1131 black glass
- DSR BX-00000-1121 light oak
- DSR BX-00000-1122 dark stained oak
- DSR BX-00000-1123 maple

i For floor connection with our digital thermostat you need to add extra DSR 56 floor sensor.

i For more thermostat info go to page 70. Thermostats are available assembled with frames only.

i For more motion sensor info go to page 70, X = chosen motion sensor type. Available assembled with frame only.



glass collection



BTA handle white + frame

- DSR XX-00201-1130 white
- DSR XX-00201-1131 black *



BTA handle black + frame

- DSR XX-00202-1130 white
- DSR XX-00202-1131 black *



OBZ handle patina + frame

- DSR XX-00103-1130 white



single outlet

- DSR Z1-Z1000-Z130 white, white cover
- DSR Z1-Z1000-Z131 black *, white cover
- DSR Z1-Z2000-Z130 white, black cover
- DSR Z1-Z2000-Z131 black *, black cover



schuko single outlet

- DSR S2-S3000-Z130 white, white cover
- DSR S2-S3000-Z131 black *, white cover
- DSR S2-S4000-Z130 white, black cover
- DSR S2-S4000-Z131 black *, black cover



HDMI outlet

- DSR 92-00000-U130 white
- DSR 92-00000-U131 black *



PC outlet

- DSR 93-00000-P130 Cat. 5E / white
- DSR 93-00000-P131 Cat.. 5E / black *
- DSR 98-00000-P130 Cat. 6 / white *
- DSR 98-00000-P131 Cat. / black *



USB-A outlet

- DSR 94-00000-U130 white
- DSR 94-00000-U131 black *



USB-A charging outlet

- DSR 95-00000-U130 white
- DSR 95-00000-U131 black *



USB-C charging outlet

- DSR 97-00000-U130 white
- DSR 97-00000-U131 black *



TV outlet

- DSR 99-00000-U130 white
- DSR 99-00000-U131 black *



SAT outlet

- DSR 2T-00000-1130 white
- DSR 2T-00000-1131 black *



EBERLE analogue ROOM thermostat under plaster mounting

- DSR 3T-00000-1130 white
- DSR 3T-00000-1131 black *



EBERLE analogue FLOOR thermostat under plaster mounting, with sensor

- DSR 4T-00000-1130 white
- DSR 4T-00000-1131 black *



digital thermostat EBERLE universal

- DSR BX-00000-1130 white
- DSR BX-00000-1131 black *



move sensor B.E.G

- DSR BX-00000-1130 white
- DSR BX-00000-1131 black *

i Glass collection offers white and black frame colours together with BTA white/black and OBZ patina handles.



i DSR Z1 / DSR S2 outlets include safety shutters. Connectors for keystone outlets can also be supplied in black color.
* Until stocks are sold out



decente

pure lines

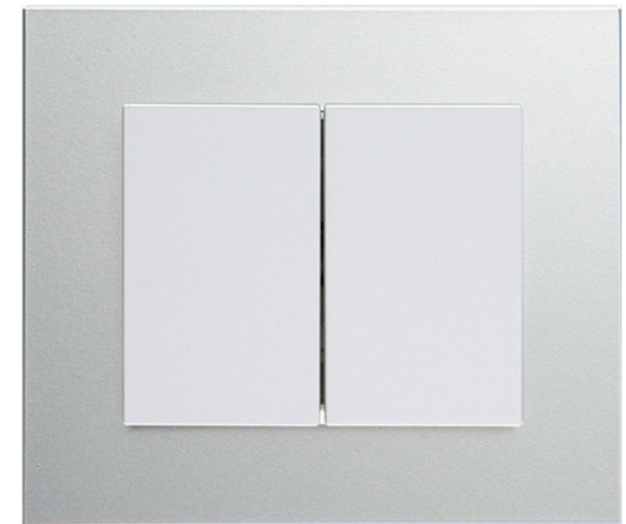

Clean lines, timeless design together with noble natural materials characterize DECENTE series. Wider, luxurious looking glass, wooden, metal or plexi-glass frames brilliantly accompany various modern interior styles. Frames of minimal thickness provide an elegant feel.

Covers are made of high quality, UV-stable plastic.



timeless design

Various materials of different shades of glass, wood, metal, and plexiglass allow for coordination with the interior according to your preferences.



wooden walnut MDF frame
/ cover white



wooden mahogany MDF frame
/ cover titanium



wooden oak MDF frame
/ cover white



glass milk white frame
/ cover white



stainless steel frame
/ cover black matt

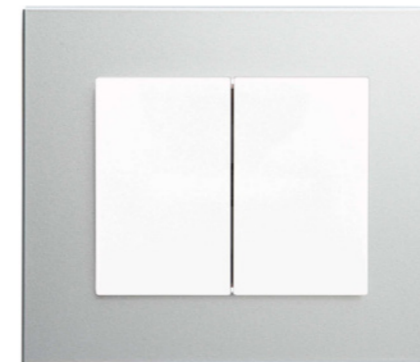

aluminium frame
/ cover white











plexiglass black frame
/ cover white



Try our online designer tool
www.domovnivypinace.cz/en



frame multiplicities

	DSD 00-00000- 11XX	dimensions (h×w) 95×110 mm
	DSD 00-00000- 12XX	dimensions (h×w) 95×181 mm
	DSD 00-00000- 13XX	dimensions (h×w) 95×252 mm
	DSD 00-00000- 14XX	dimensions (h×w) 95×323 mm
	DSD 00-00000- 21XX	dimensions (h×w) 166×110 mm
	DSD 00-00000- 31XX	dimensions (h×w) 237×110 mm
	DSD 00-00000- 41XX	dimensions (h×w) 308×110 mm
	DSD 00-00000- 82XX	dimensions (h×w) 130×110 mm













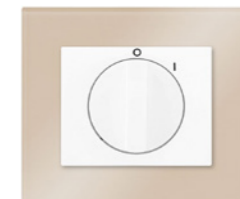

















 Please note that horizontal and vertical multiple frames have different design.



glass triple frame dove grey / graphite covers

sets

				
switch arrangement (arrangement 1, 1N, 2, 6, 7, 1/0, 1/0N), press button up to 24V	switch arrangement (arrangement 5, 1+1/0, 1/0+1/0, 6+6), press button up to 24V	switch with backlighting (arrangement 1S, 2S, 1N, 1/0N, 1/0)	rotary cooker switch three-pole 16 A	rotary shutter controller two-pole (arrangement 1/0+1/0 with locking)
				
shutter controller, rocker switch (arrangement 1/0+1/0, 6/0+6/0 with simultaneous operation electric lock)	rotary dimmer with arr. function 6, also LED rotary dimmer	AUDIO-VIDEO outlet (stereo)	aerial outlet (TV+R+SAT) terminal 1 dB (ZAR-SAT 1,4/K) through 10 dB (ZAR-SAT 10/P3)	aerial outlet (TV+SAT+SAT) through 10 dB (ZAR-SAT 10/P3)
				
single outlet with safety shutters (2P+PE)	single outlet with safety shutters and overvoltage protection (2P+PE) LIGHT INDICATION	single outlet with safety shutters and overvoltage protection (2P+PE) AUDIBLE ALARM	schuko single outlet with safety shutters (2P+PE)	schuko single outlet with safety shutters and overvoltage protection (2P+PE) LIGHT INDICATION
				
double outlet with safety shutters 2x (2P+PE)	double outlet with safety shutters and overvoltage protection 2x (2P+PE) LIGHT INDICATION	single outlet with safety shutters and a IP20 covering lid (2P+PE)	double communication outlet (RJ 45 - 8 Cat. 5E) (RJ 45 - 8 Cat. 6) (RJ 45 Cat. 6 shielded) (RJ 45 Cat. 6A shielded)	double telephone outlet (TZ-1A/2A) with loop checking (TZU-1A/2A)
				
OREG/EBERLE 2T/3T analog thermostat ROOM/FLOOR under-plaster	EBERLE DSD 4T digital thermostat UNIVERSAL (application as floor and corn-bined, it is necessary to buy a sensor) under-plaster	B.E.G. motion sensor	HDMI+PC outlet 2 connectors, HDMI female + PC outlet Cat. 5E / RJ 45-8 for UTP cable	USB+PC outlet 2 connectors, USB 3.0 female + PC outlet Cat. 5E / RJ 45-8 for UTP cable
				
USB-A outlet with charger + HDMI 2 connectors, USB 3.0 female + HDMI female	2x USB-A outlet with charger 2 connectors USB 3.0 female	2x USB-C outlet with charger 2,1 A, 10,5 W		

 Connectors for keystone outlets can also be supplied in black color.

frames

glass

57 snow white (RAL 9003)	50 milk white (RAL 9010)	52 dove grey (RAL 7035)	59 cream white (RAL 1013)
5A mocca (REF 1236)	5F white matt (REF 9003)	5G bronze matt	5E metal grey matt (RAL 9006)
58 anthracite black (RAL 9005)	5K black matt (REF 9005)	5H* mirror bronze	5J mirror steel
5C* indigo (REF 0627)	53* ice green (RAL 6019)	55* palm green (RAL 1060)	51* brick orange (RAL 2001)
54* cherry red (RAL 3001)	56* chocolate brown (RAL 8017)		

wood **

60 MDF oak **	61 MDF walnut **	62* MDF mahogany **
------------------	---------------------	------------------------

metal

70 aluminium	71 stainless steel
-----------------	-----------------------

plexi

80 white (RAL 9003)	81 black (RAL 9005)
---------------------------	---------------------------

plexiglass

82 white (RAL 9003)	83* black (RAL 9005)	84* grey (RAL 9006)
---------------------------	----------------------------	---------------------------

covers

single cover for switches: 1, 2, 6, 7, 1/0, 1/0N DSD 00-010YY-0000	cover for a shutter controller with rotary controller DSD 00-216YY-0000	cover for a cooker switch with rotary controller DSD 00-215YY-0000
single cover with backlighting DSD 00-030YY-0000	double cover for shutter controller DSD 00-026YY-0000	cover for a dimmer DSD 00-270XX-0000
double cover for switches: 5, 6+6, 1/0+1/0, 1/0+1 DSD 00-020YY-0000	single outlet cover with safety shutters and IP20 covering lid, 2P+PE DSD 00-870YY-0000	cover for a LED dimmer DSD 00-230XX-0000
cover for a single outlet with safety shutters 2P+PE DSD 00-810YY-0000	schuko outlet cover, single with safety shutters and IP20 covering lid, 2P+PE DSD 00-880YY-0000	blind cover DSD 00-050YY-0000
cover for a single outlet with overvoltage protection 2P+PE DSD 00-840YY-0000	outlet cover for TV+R+SAT TV+SAT+SAT AUDIO-VIDEO DSD 00-970YY-0000	cover for telephone outlet, double DSD 00-910YY-0000
schuko outlet cover, single with safety shutters 2P+PE DSD 00-830YY-0000	cover for a double outlet with safety shutters 2x (2P+PE) DSD 00-820YY-0000	cover for a double communication outlet DSD 00-930YY-0000
schuko outlet cover, single with safety shutters and overvoltage protection 2P+PE DSD 00-860YY-0000	cover for a double outlet with safety shutters and overvoltage protection 2x (2P+PE) DSD 00-850YY-0000	outlet cover HDMI, PC, USB, USB-C DSD 00-920YY-0000
single cover for passive short press switch for home automation DSD 00-K100X-0000	double cover for passive short press switch for home automation DSD 00-K200X-0000	

cover colours

01 snow white glossy	35 white matt	30 aluminium	32 gold
02 anthracite black glossy	34 black matt	31 graphite	33 titanium



* Until stocks are sold out
** Please note that due to uniqueness of natural wooden materials used for DECENTE frames, these may not always be the same, their colour tone and pattern may vary. Colour tones may differ slightly from reality.



ORDER CODE:
DSD 00-00000-XXXX







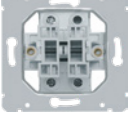

ORDER CODE:
DSD 00-000YY-0000

fittings

-  **fitting, arrangement 1**
singlepole switch
10 AX, 250 V AC
DSD 01-00000-0000
-  **fitting, arrangement 1N**
singlepole switch with a zero terminal
10 AX, 250 V AC
DSD 12-00000-0000
-  **fitting, arrangement 2**
twopole switch
10 AX, 250 V AC
DSD 02-00000-0000
-  **fitting, arrangement 5**
serial change-over switch
10 AX, 250 V AC
DSD 05-00000-0000
-  **fitting, arrangement 6**
ac change-over switch
10 AX, 250 V AC
DSD 06-00000-0000
-  **fitting, arrangement 6+6 (6+1)**
ac change-over switch,
double 10 AX, 250 V AC
DSD 66-00000-0000
-  **fitting, arrangement 7**
crossbar switch
10 AX, 250 V AC
DSD 07-00000-0000
-  **fitting, arrangement 1/0**
switching controller
10 AX, 250 V AC
DSD 10-00000-0000
-  **fitting, arrangement 1/0+1/0**
switching controller, double
10 AX, 250 V AC
also suitable as shutter switch without locking
DSD 11-00000-0000
-  **fitting, arrangement 1/0N**
switching controller with a zero terminal
10 AX, 250 V AC
DSD 13-00000-0000
-  **fitting, arrangement 1/0+1**
switching controller
+ singlepole switch
10 AX, 250 V AC
DSD 14-00000-0000
-  **fitting, arrangement 6/0+6/0**
shutter switch with locking
10 AX, 250 V AC
DSD 16-00000-0000



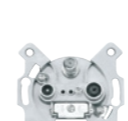

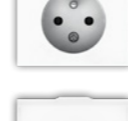



- fitting, arrangement 1+1**
singlepole switch
+ singlepole switch
10 AX, 250 V AC
DSD 15-00000-0000

-  **fitting, arrangement 1/0,
press button, up to 24 V**
50 mA, 24 V DC
DSD 17-00000-0000
-  **fitting, arrangement 1/0 + 1/0,
press button, up to 24 V**
50 mA, 24 V DC
DSD 18-00000-0000
-  **passive short-press switch**
switch for intelligent systems
50 mA, 12 V DC
DSD KC-00000-0000
-  **passive short press switch**
for intelligent systems
with KNX module
21-30 V DC
DSD KX-00000-0000
-  **AUDIO-VIDEO outlet**
stereo (2+1)
DSD 72-00000-0000
-  **fitting for cooker switch, rotary**
threepole
16 A, 400 V AC
recommended min. depth of installation box - 60 mm
DSD 21-00000-0000
-  **fitting for shutter controller**
rotary (with locking)
10 A, 230 V AC
recommended min. depth of installation box - 60 mm
DSD 22-00000-0000
-  **dimmer fitting with
arrangement 6**
230 V AC, load
40-250 W
DSD 27-00000-0000
-  **LED dimmer fitting**
230 V AC, load 0-100 W LED,
10-250 W incandescent
light bulb
DSD 23-00000-0000
-  **telephone outlet**
double
TZ-1A2A, TZU
DSD 91-00000-0000
-  **communication outlet Cat. 5E / Cat. 6**
double PC outlet, black connectors
2x RJ 45-8 for UTP cable
DSD 93-00000-0000 Cat. 5
DSD 98-00000-0000 Cat. 6
-  **communication outlet Cat. 6 / Cat. 6A**
double PC outlet, black connectors
2x RJ 45 shielded for STP cable
DSD 74-00000-0000 Cat. 6
DSD 75-00000-0000 Cat. 6A
-  **HDMI+PC socket**
2 connectors: HDMI female
+ PC outlet Cat. 5E for utp cable
DSD 92-00000-0000
-  **USB-A+PC socket**
2 connectors: USB 3.0 female
+ PC outlet Cat. 5E for utp cable
DSD 94-00000-0000

-  **USB-A outlet with charger + HDMI**
2 connectors: USB 3.0 female
+ HDMI female, white connectors
(1000 mA)
DSD 95-00000-0000
-  **2x USB-A outlet with charger**
2 connectors: USB 3.0 female
2 connectors, 5 V DC / 1000 mA
DSD 96-00000-0000
-  **2x USB-C outlet with charger**
2 connectors: USB-C charger
2,1 A, 10,5 W
DSD 9C-00000-0000
-  **outlet TV+R+SAT**
terminal, attenuation 1 dB, 300 mA, 24 V DC
for coaxial cables of diameter 4.5-8.3 mm
type designation on the product: ZAR-SAT 1.4/K
DSD 97-00000-0000
-  **outlet TV+R+SAT**
through, attenuation 10 dB, 300 mA, 24 V DC
for coaxial cables of diameter 4.5-8.3 mm
type designation on the product: ZAR-SAT 10/P3
DSD 99-00000-0000
-  **outlet TV+SAT+SAT**
through, attenuation 10 dB, 300 mA, 24 V DC
for coaxial cables of diameter 4.5-8.3 mm
type designation on the product: ZAR-SAT 10/P3
DSD 76-00000-0000
-  **outlet 2P+PE**
single socket with safety shutters and IP 20
covering lid, plastic base 16 A, 250 V AC
DSD 89-870YY-0000
-  **outlet schuko 2P+PE**
single socket with safety shutters and IP 20
covering lid, plastic base 16 A, 250 V AC
DSD S2-880YY-0000

-  **2P+PE outlet**
single, with safety shutters, plastic base
16 A, 250 V AC
DSD 89-810YY-0000
-  **2P+PE with OP outlet**
single, with safety shutters and overvoltage
protection (LIGHT INDICATION)
16 A, 250 V AC
DSD 84-840YY-0000
-  **2P+PE with OP outlet**
single, with safety shutters and overvoltage
protection (AUDIBLE ALARM)
16 A, 250 V AC
DSD 80-810YY-0000
-  **2P+PE schuko outlet**
single, with safety shutters
16 A, 250 V AC
DSD S2-830YY-0000
-  **2P+PE with OP schuko outlet**
single, with safety shutters and overvoltage
protection (LIGHT INDICATION)
16 A, 250 V AC
DSD S3-860YY-0000
-  **2x (2P+PE) outlet**
double, with safety shutters
16 A, 250 V AC
DSD 82-820YY-0000
-  **2x (2P+PE) OP outlet**
double, with safety shutters and with
overvoltage protection (LIGHT INDICATION)
16 A, 250 V AC I max 4.5 kA, Up < 1.2 kV
DSD 85-850YY-0000

outlet cover colours

- | | | | | | | | |
|---|---|---|-------------------------|---|------------------------|---|-----------------------|
|  | 01
snow white
glossy |  | 35
white matt |  | 30
aluminium |  | 32
gold |
|  | 02
anthracite black
glossy |  | 34
black matt |  | 31
graphite |  | 33
titanium |



Power outlets always come in set with a cover of your choice.

accessories



PC connector Cat. 5E
RJ 45 black plastic
set of 2 pcs
for UTP cable

DSE 33-00000-000000



PC connector Cat. 6
RJ 45 black plastic
set of 2 pcs
for UTP cable

DSE 34-00000-000000



PC connector Cat. 6 shielded
RJ 45 Cat. 6
set of 2 pcs
for STP cable

DSE 24-00000-000000



PC connector Cat. 6A shielded
RJ 45 Cat. 6A
set of 2 pcs
for STP cable

DSE 25-00000-000000



spacer VK1
fills up the gap between installation
box and fitting

DSE 29-00000-000000



spacer VK2
fills up the gap between installation
box and fitting

DSE 30-00000-000000



connector CINCH AUDIO-VIDEO
mono
set of 2 pcs

DSE 38-00000-000000



connector CINCH AUDIO-VIDEO
stereo
set of 3 pcs

DSE 39-00000-000000



glow lamp
230 V, 2 MA

DSE 3A-00000-000000 orange

230 V, 0,5 MA

DSE 3B-00000-000000 green

DSE 3C-00000-000000 blue



fixative spurs (claws)
set of 2 pcs

DSE 37-00000-000000



support frame for PC connectors
for DECENTE and ELEGANT line

DSE 35-00000-000000



support frame for HDMI and USB connectors
for DECENTE line

DSD 35-00000-0000



HDMI-A keystone
female-female, 4K, 60 Hz, 1 pc

3453685 black

3453686 white



USB-A keystone-charger
2.1 A, 10,5 W, 1 pc

3450546 black

3453672 white



USB-C keystone-charger
2.1 A, 10,5 W, 1 pc

3453678 black

3453679 white



decente

hotel systems

*comfortable for guests, simple
and effective for staff*

ACS-line Reception Hotel System by Estelar Company is designed to secure all activities related to running a hotel or pension. The system includes wall-mounted card readers and energy savers in Decente design available in all standard colours and materials which can match other switches and outlets in Decente design. One hotel card will allow room access, lift control, access to authorized areas (parking, wellness, etc.), payments in hotel bars and restaurants, use of other services (bike rental, ski passes, etc.).



ESTELAR
ELEKTRONICKE SYSTÉMY

card reader

Card reader (built-in card scanner) is a device for reading cards and controlling individual access according to permission. Typical use is e.g. opening of hotel entrance door, hotel room access, opening of wellness door within allowed time.

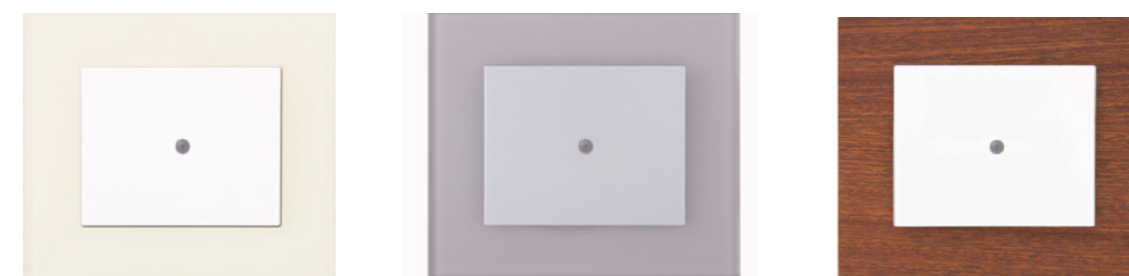

ORDER CODE:
DSD 00-CK0YY-H1XX

energy saver

Energy Saver is a device that allows to insert a card and thereby invoke an action that lasts while the card is inserted. The device is equipped with a card reader and responds only to authorized cards, so it is not possible to replace the card with for example sturdy paper. Typical use is in a hotel room where the wiring is active only in the presence of a guest or for light control in the meeting room according to its occupancy. Connection of heating sensors for controlling room temperature is also available.



The producer of hotel card readers and hotel systems is ESTELAR, s. r. o.
More info to be found at www.acsline.cz.



Card readers are offered in DECENTE design with white, black or metallic cover.
Frame can be chosen from glass, wood, metal, plexi or plexiglass collection.



ORDER CODE:
DSD 00-HK0YY-H1XX

decente

smart home solution



smart home solution

The so-called smart house or home automation provide not only high living comfort, save energy costs, increase safety and entertainment at your fingertips.

Smart home can be controlled by:

- wall mounted short press switches - which you can choose from our timeless DECENTE design
- touch panels
- devices running on iOS or Android systems (computers, smartphones,...)
- TV
- LAN
- sensors and other controllers connected to main central-control unit



compatible smart systems



LOXONE



elegant

*conventional shape,
rounded lines*



A classic, unobtrusively elegant design with rounded lines and tens of colours to choose from will create a harmonious relationship with any type of interior. Both frame and cover are made of high quality plastic. Soft pastel tones will gently bring up the atmosphere of your interior while rich and colourful on the contrary will play the role of strong accent and attract attention to detail – the switch itself. We also offer our best-selling metallic colours: aluminium, graphite, gold and titanium.

custom switches

Our unique design allows you to combine any two colours within the frame. Your switch can then look maybe like

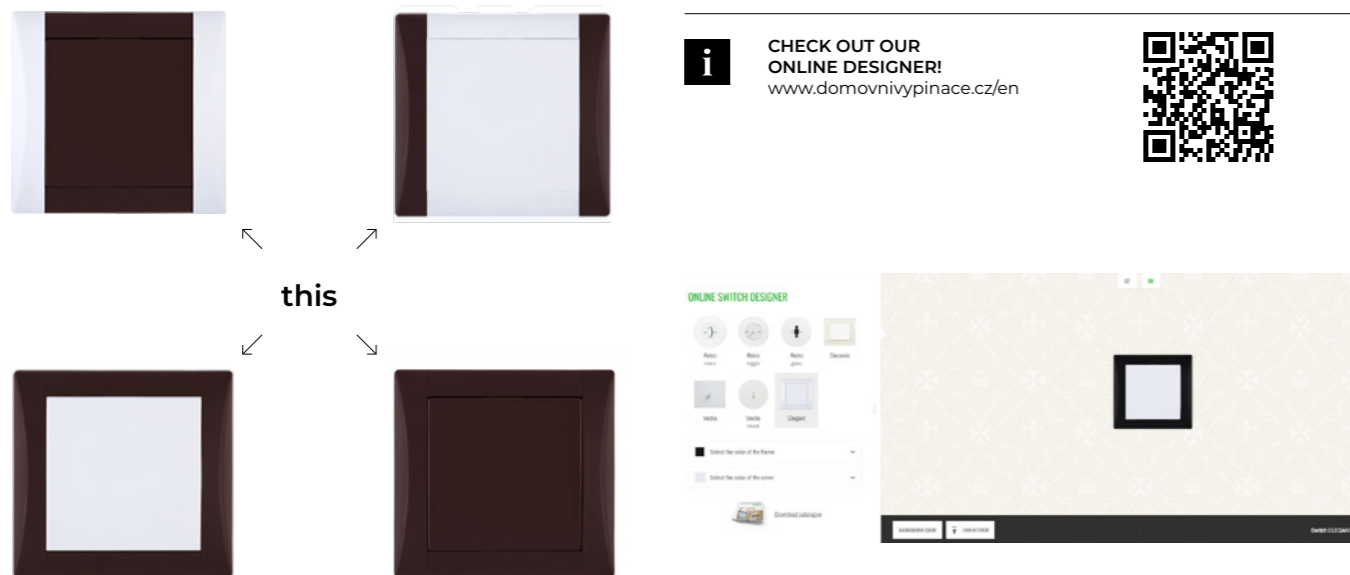

i Frames can be combined with covers of any colour. Unique frame design also allows a combination of base and side segments using any combination of two colours. We are always happy to advise you on the selection.

complex wiring solution in elegant design

The unusual design of the frame connection makes possible to create: up to seven horizontal or triple vertical combinations modul combinations up to 2x5 positions.

the product line includes

- switches, outlets, controllers
- ELEGANT Aqua (IP 44)
- ELEGANT Medical
- vacuum outlets
- thermostats
- motion sensors

for your cosy interior

Do you fancy a modern, but also cosy interior where you could use curtains, carpets and other decorations you have personal feelings for? Gentle tones of grey, beige and brown switches would fit right in. These colours do not grow old and will leave you space for further creativity when equipping your interior with other accessories.



cappuccino frame / cover cappuccino



steel grey frame / cover steel grey

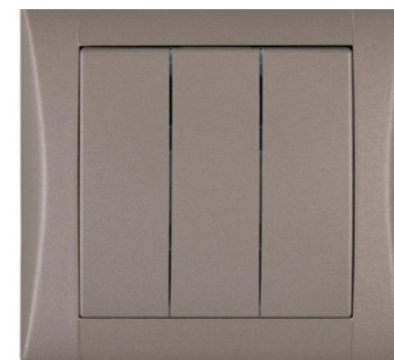

titanium frame / cover titanium grey



sets

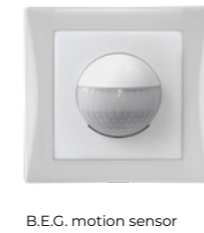
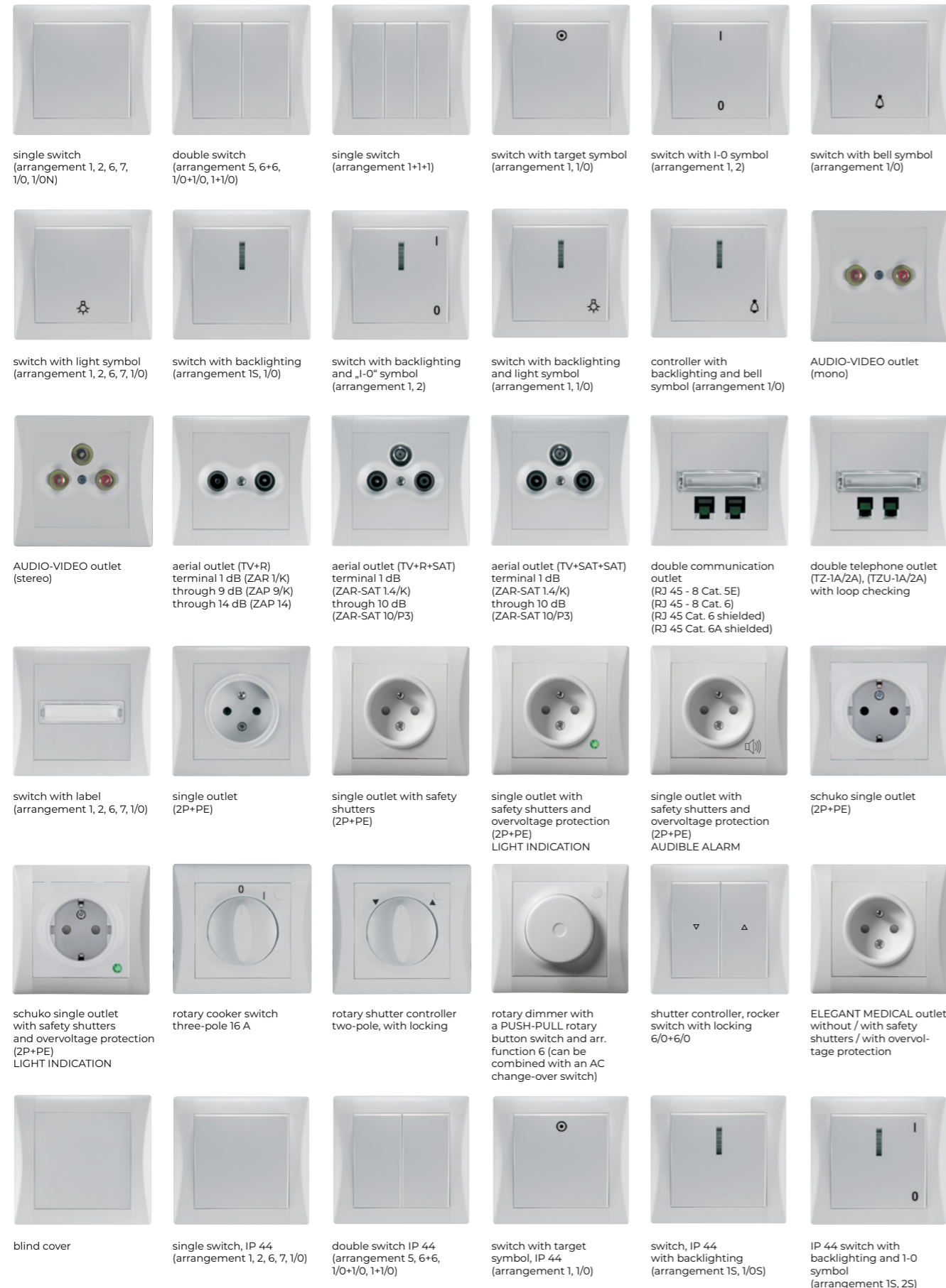

i Slightly rotated outlet cavities allow comfortable plugging in of two devices.

















frames

 01 snow white	 06* peach orange	 18 cappuccino	 30 aluminium
 02 anthracite black	 08* ice green	 19 steel grey	 31 graphite
 03 smoke grey	 09* sunflower yellow	 20* olive grey	 32 gold
 04* vanilla yellow	 10 signal brown	 21 nut brown	 33 titanium
 05 sandy beige	 11* ruby red		

i * Until stocks are sold out.
Colour tones may differ slightly from reality.
Single switch (arrangement 1+1) is only available in white snow, anthracite black, aluminium, graphite, gold and titanium.

frame multiplicities

 DSE 00-00000-11XXXX	dimensions (h*w) 84*89 mm	 DSE 00-00000-21XXXX	dimensions (h*w) 155*89 mm
 DSE 00-00000-82XXXX	double outlet frame dimensions (h*w) 115*89 mm	 DSE 00-00000-31XXXX	dimensions (h*w) 226*89 mm
 DSE 00-00000-12XXXX	dimensions (h*w) 84*160 mm	 DSE 00-00000-22XXXX	dimensions (h*w) 155*160 mm
 DSE 00-00000-13XXXX	dimensions (h*w) 84*231 mm	 DSE 00-00000-23XXXX	dimensions (h*w) 155*231 mm
 DSE 00-00000-14XXXX	dimensions (h*w) 84*302 mm	 DSE 00-00000-24XXXX	dimensions (h*w) 155*302 mm
 DSE 00-00000-15XXXX	dimensions (h*w) 84*373 mm	 DSE 00-00000-25XXXX	dimensions (h*w) 155*373 mm
 DSE 00-00000-16XXXX	dimensions (h*w) 84*444 mm		
 DSE 00-00000-17XXXX	dimensions (h*w) 84*515 mm		

i Please note that horizontal and vertical multiple frames have different design.

i **ORDER CODE:**
DSE 00-00000-XXXXXX

covers

 single cover for switches: 1, 2, 6, 7, 1/0, 1/0N, 1N DSE 00-010YY-000000	 single cover with backlighting with 0-1 symbol for switches fitted with glow-lamp: 1, 1N, 2, 1/0, 1/0N DSE 00-031YY-000000	 double cover for switches: 5, 6+6, 1/0+1/0, 1/0+1 DSE 00-020YY-000000
 single cover with 0-1 symbol for switches: 1, 2, 6, 7, 1/0 DSE 00-011YY-000000	 single cover with a labeling field DSE 00-040YY-000000	 triple cover for switches: 1+1+1 DSE 00-V30YY-000000
 single cover with target symbol for switches: 1, 1/0 DSE 00-012YY-000000	 cover for a single outlet with safety shutters 2P+PE DSE 00-890YY-000000	 cover for shutter controller with rotary controller DSE 00-216YY-000000
 single cover with the bell symbol for switches: 1/0 DSE 00-013YY-000000	 cover for a single outlet with overvoltage protection 2P+PE DSE 00-840YY-000000	 cover for cooker switch with rotary controller DSE 00-215YY-000000
 cover for a dimmer / cover for LED dimmer DSE 00-270YY-000000 DSE 00-230YY-000000	 schuko outlet cover 2P+PE DSE 00-830YY-000000	 double cover for shutter controller DSE 00-026YY-000000
 blind cover DSE 00-050YY-000000	 schuko outlet cover with overvoltage protection 2P+PE DSE 00-860YY-000000	 outlet cover double 2x (2P+PE) DSE 00-820YY-000000
 cover for a telephone outlet, double DSE 00-910YY-000000	 outlet cover TV+R / AUDIO-VIDEO mono DSE 00-940YY-000000	 cover for a double outlet with safety shutters 2x (2P+PE) DSE 00-870YY-000000
 cover for a double communication outlet DSE 00-930YY-000000	 outlet cover TV+R+SAT (TV+SAT+SAT) AUDIO-VIDEO stereo DSE 00-970YY-000000	 cover for a double outlet with overvoltage protection and safety shutters 2x (2P+PE) DSE 00-850YY-000000
 single cover with backlighting for switches fitted with glow-lamp: 1, 1N, 2, 1/0, 1/0N DSE 00-030YY-000000	 single cover with backlighting with light symbol for switches fitted with glow-lamp: 1, 1N, 2, 1/0, 1/0N DSE 00-034YY-000000	
 single cover with light symbol for switches: 1, 2, 6, 7, 1/0 DSE 00-014YY-000000	 single cover with backlighting with bell symbol for switches fitted with glow-lamp: 1/0, 1/0N DSE 00-033YY-000000	







i ORDER CODE:
DSE 00-YYYYY-000000

cover colours

 57 snow white	 06* peach orange	 18 cappuccino	 30 aluminium
 02 anthracite black	 08* ice green	 19 steel grey	 31 graphite
 03 smoke grey	 09* sunflower yellow	 20* olive grey	 32 gold
 04* vanilla yellow	 10 signal brown	 21 nut brown	 33 titanium
 05 sandy beige	 11* ruby red		

i * Until stocks are sold out. Colour tones may differ slightly from reality. Single switch (arrangement 1+1) is only available in white snow, anthracite black, aluminium, graphite, gold and titanium.

elegant aqua IP 44 covers

 single cover IP 44 for switches: 1, 2, 6, 7, 1/0 DSE 00-510YY-000000	 single cover IP 44 with target symbol for switches: 1, 1/0 DSE 00-512YY-000000
 single cover IP 44 with backlighting for switches fitted with a glow-lamp: 1, 1N, 2, 1/0, 1/0N DSE 00-540YY-000000	 IP 44 single outlet cover with a lid and safety shutters 2P+PE Available colours only 01, 30, 31, 32, 33. The IP44 outlet is always supplied with a transparent (milk white) lid. DSE 00-530YY-000000
 double cover IP 44 for switches: 5, 6+6, 1/0+1/0, 1/0+1 DSE 00-520YY-000000	 IP 44 schuko outlet cover with a lid and safety shutters 2P+PE Available colours only 01, 30, 31, 32, 33. The IP44 outlet is always supplied with a transparent (milk white) lid. DSE 00-530YY-000000
 single cover IP 44 with backlighting and 0-1 for switches fitted with a glow-lamp: 1, 1N, 2, 1/0, 1/0N DSE 00-541YY-000000	

i For ELEGANT AQUA cover colours go to page 61.

fittings



fitting, arrangement 1
singlepole switch
10 AX, 250 V AC

DSE 01-00000-000000



fitting, arrangement 12
in singlepole switch
with zero terminal
10 AX, 250 V AC

DSE 12-00000-000000



fitting, arrangement 2
twopole switch
10 AX, 250 V AC

DSE 02-00000-000000



fitting, arrangement 5
serial change-over switch
10 AX, 250 V AC

DSE 05-00000-000000

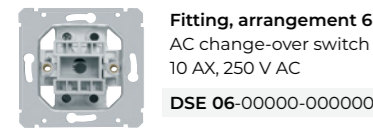

fitting, arrangement 6
AC change-over switch
10 AX, 250 V AC

DSE 06-00000-000000

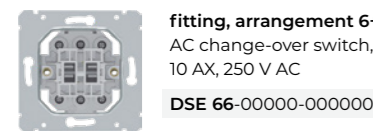

fitting, arrangement 6+6 (6+1)
AC change-over switch, double
10 AX, 250 V AC

DSE 66-00000-000000



fitting, arrangement 7
crossbar switch
10 AX, 250 V A

DSE 07-00000-000000

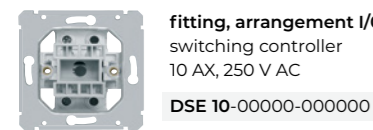

fitting, arrangement 1/0
switching controller
10 AX, 250 V AC

DSE 10-00000-000000



fitting, arrangement 6/0+6/0
shutter switch with locking
10 AX, 250 V AC

DSE 16-00000-000000



fitting, arrangement 13
ON switching controller
with zero terminal
10 AX, 250 V AC

DSE 13-00000-000000



fitting, arrangement 14
switching controller
+ singlepole switch
10 AX, 250 V AC

DSE 14-00000-000000



fitting, arrangement 15
singlepole switch
+ singlepole switch
10 AX, 250 V AC

DSE 15-00000-000000



fitting, arrangement 17
1/0 + 1/0,
press button, up to 24 V
50 mA, 24 V DC

DSE 17-00000-000000

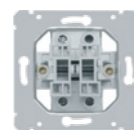

fitting, arrangement 11
double switching controller
10 AX, 250 V AC
Ize použit jako žaluziový ovladač bez blokace

DSE 11-00000-000000

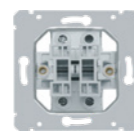

fitting, arrangement 18
press button, up to 24 V
50 mA, 24 V DC

DSE 18-00000-000000

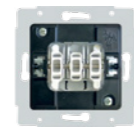

fitting, arrangement V3
(3x singlepole switch)
10 AX, 250 V AC

DSE V3-00000-000000

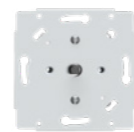

fitting for cooker switch, rotary
threepole
16 A, 400 V AC

DSE 21-00000-000000



fitting for shutter controller, rotary
(with locking)
10 A, 230 V AC

DSE 22-00000-000000



fitting for rotary dimmer
with arrangement 6
230 V AC,
load 40–250 W

DSE 27-00000-000000

fitting for LED dimmer
230 V AC, load
0–100 W LED, 10–250 W
incandescent light bulb

DSE 23-00000-000000

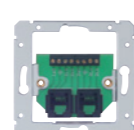

telephone outlet double
TZ-1A2A
connectors black

DSE 91-00000-000000



telephone outlet double,
with loop checking
TZU-1A2A
connectors black

DSE 92-00000-000000



communication outlet Cat. 5E double
2x RJ 45 Cat. 5E
for UTP cable
connectors black

DSE 93-00000-000000



communication outlet Cat. 6 double
2x RJ 45 Cat. 6
for UTP cable
connectors black

DSE 98-00000-000000



communication outlet Cat. 6 double
2x RJ 45 Cat. 6 shielded
for STP cable
connectors black

DSE 74-00000-000000



communication outlet Cat. 6A double
2x RJ 45 Cat. 6A shielded
for STP cable
connectors black

DSE 75-00000-000000

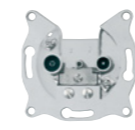

TV+R outlet terminal
attenuation 1 dB, 350 mA, 24 V DC
for coaxial cables of diameter 4.5–8.3 mm
designation on the product: ZAR 1/K

DSE 94-00000-000000



TV+R outlet through
branching attenuation 9 dB
for coaxial cables of diameter 4.5–8.3 mm
designation on the product: ZAP 9/K

DSE 95-00000-000000

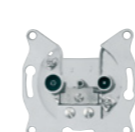

TV+R outlet through
branching attenuation 14 dB
for coaxial cables of diameter 4.5–8.3 mm
designation on the product: ZAP 14

DSE 96-00000-000000

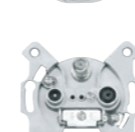

TV+R+SAT outlet
terminal, attenuation 1 dB, 300 mA, 24 V DC
for coaxial cables of diameter 4.5–8.3 mm
designation on the product: ZAR-SAT 1.4/K

DSE 97-00000-000000

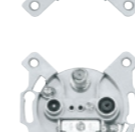

TV+R+SAT outlet
through, attenuation 10 dB, 300 mA, 24 V DC
for coaxial cables of diameter 4.5–8.3 mm
designation on the product: ZAR-SAT 10/P3

DSE 99-00000-000000



TV+SAT+SAT outlet
through, attenuation 10 dB, 300 mA, 24 V DC
for coaxial cables of diameter 4.5–8.3 mm
designation on the product: ZAR-SAT 10/P3

DSE 76-00000-000000

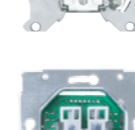

passive short-press switch
switch for intelligent systems
50 mA, 12 or 24 V DC

DSE KC-00000-000000



AUDIO-VIDEO outlet
mono (1+1)

DSE 71-00000-000000



AUDIO-VIDEO outlet
stereo (2+1)

DSE 72-00000-000000



terminal for potential equalization
protective bonding outlet 5x terminal
up to 2.5 mm², 1x terminal up to 6 mm

DSE 79-79001-000000



2P+PE outlet
single
16 A, 250 V AC

DSE Z1-890YY-000000



2P+PE outlet
single with safety shutters
16 A, 250 V AC

DSE 89-890YY-000000



2P+PE outlet
single with safety shutters
16 A, 250 V AC

DSE 89-890YY-000000



2P+PE with OP outlet
single with safety shutters and overvoltage protection,
(LIGHT INDICATION) 16 A, 250 V AC, I max 4.5 kA,
Up < 1.2kV

DSE 84-840YY-000000



2P+PE with OP outlet
single with safety shutters and overvoltage protection,
(AUDIBLE ALARM) 16 A, 250 V AC, Up < 1.2 kV

DSE 80-890YY-000000



2P+PE schuko outlet
single
16 A, 250 V AC

DSE S1-830YY-000000



2P+PE schuko outlet
single with safety shutters
16 A, 250 V AC

DSE S2-830YY-000000



2P+PE with OP schuko outlet
single with safety shutters and overvoltage protection,
(LIGHT INDICATION), 16 A, 250 V AC

DSE S3-860YY-000000



2P+PE, IP 44 outlet
with lid and safety shutters 16 A, 250 V AC

DSE 89-530YY-000000



Available colour only 01, 30, 31, 32, 33.
IP 44 outlet is always supplied with transparent (milk white) lid.

2P+PE schuko outlet
with lid and safety shutters 16 A, 250 V AC

DSE S2-550YY-000000



Available colour only 01, 30, 31, 32, 33.
IP 44 outlet is always supplied with transparent (milk white) lid.

2x (2P+PE) outlet
double
16 A, 250 V AC

DSE 82-820YY-000000



2x (2P+PE) outlet
double with safety shutters (ELEGANT only)
16 A, 250 V AC

DSE 87-870YY-000000



2x (2P+PE) with OP outlet
double with safety shutters and overvoltage
protection (LIGHT INDICATION)
16 A, 250 V AC, I max 4.5 kA, Up < 1.2 kV

DSE 85-850YY-000000

accessories



PC connector Cat. 5E
RJ 45 black plastic
set of 2 pcs
for UTP cable

DSE 33-00000-000000



PC connector Cat. 6
RJ 45 black plastic
set of 2 pcs
for UTP cable

DSE 34-00000-000000



PC connector Cat. 6 shielded
RJ 45 Cat. 6
set of 2 pcs
for STP cable

DSE 24-00000-000000



PC connector Cat. 6A shielded
RJ 45 Cat. 6A
set of 2 pcs
for STP cable

DSE 25-00000-000000



spacer VK1
fills up the gap between installation box and fitting

DSE 29-00000-000000



spacer VK2
fills up the gap between installation box and fitting

DSE 30-00000-000000

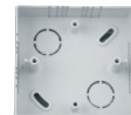

single box for strip distribution systems
(only for ELEGANT)

DSE 31-00000-000000



double outlet box for strip distribution systems
(only for ELEGANT)

DSE 36-00000-000000



connector CINCH AUDIO-VIDEO
mono
set of 2 pcs

DSE 38-00000-000000



connector CINCH AUDIO-VIDEO
stereo
set of 3 pcs

DSE 39-00000-000000



glow lamp
230 V, 2 MA

DSE 3A-00000-000000 orange

230 V, 0,5 MA

DSE 3B-00000-000000 green

DSE 3C-00000-000000 blue



fixative spurs (claws)
set of 2 pcs

DSE 37-00000-000000



support frame for PC connectors

DSE 35-00000-000000



5103 MDE mounting plate
for central vacuum cleaner outlets

DSE 26-00000-000000



elegant

aqua IP 44

*safety first not only
in your bathroom*



IP 44 switches and outlets

ELEGANT AQUA series devices are designed for flush mounting and are supplied with IP 44 protection. These can be used in dusty, damp (bathrooms, warehouses, workshops, garages etc.) or outdoor areas.

XXXX = YY =	2001 - olive grey * 01 - white	1901 - steel grey 01 - white	1801 - cappuccino 01 - white	2101 - nut brown 01 - white	1101 - ruby red * 01 - white	
XXXX = YY =	0401 - vanilla yellow * 01 - white	0901 - sunflower yellow * 01 - white	0601 - peach orange * 01 - white	1001 - signal brown 01 - white	0101 - snow white 01 - white	
XXXX = YY =	0501 - sandy beige 01 - white	0801 - ice green * 01 - white	0301 - smoke grey 01 - white	0201 - anthracite black 01 - white		
XXXX = YY =	3030 - aluminium 01 - white	3131 - graphite 01 - white	3232 - gold 01 - white	3333 - titanium 01 - white	single outlet with transparent lid	
XXXX = YY =	3030 - aluminium 30 - aluminium	3131 - graphite 31 - graphite	3232 - gold 32 - gold	3333 - titanium 33 - titanium	schuko outlet with transparent lid	



Only the colour combinations shown are available for the IP 44 in the ELEGANT range. The IP 44 socket is always supplied with a transparent (milk white) lid.



ORDER CODE:
DSE 00-510YY-51XXXX



IP 44 protection can be used with outlets and switches (arrangements 1, 2, 6, 7, 1/0, 5, 6+6, 1/0+1/0, 1+1/0).

* Until stocks are sold out.

elegant

vacuum outlets



vacuum outlets

ELEGANT vacuum outlets are designed to be installed in modern interiors. Colours and shape perfectly match ELEGANT switches and socket outlets. They are compatible with BEAM central vacuuming systems.

XXXX = YY =	2001 - olive grey * 01 - white	1901 - steel grey 01 - white	1801 - cappuccino 01 - white	2101 - nut brown 01 - white	1001 - signal brown 01 - white	0201 - anthracite black 01 - white
XXXX = YY =	0401 - vanilla yellow * 01 - white	0901 - sunflower yellow * 01 - white	0601 - peach orange * 01 - white	1101 - ruby red * 01 - white	0501 - sandy beige 01 - white	0801 - ice green * 01 - white
XXXX = YY =	3001 - aluminium 01 - white	3101 - graphite 01 - white	3201 - gold 01 - white	3301 - titanium 01 - white	0301 - smoke grey 01 - white	0101 - snow white 01 - white
XXXX = YY =	3030 - aluminium 01 - white	3131 - graphite 01 - white	3232 - gold 01 - white	3333 - titanium 01 - white		
XXXX = YY =	3030 - aluminium 30 - aluminium	3131 - graphite 31 - graphite	3232 - gold 32 - gold	3333 - titanium 33 - titanium	assembly plate DSE 26-00000-00000	

i ELEGANT vacuum cleaners are only available in the colour combinations shown. The mounting plate is not included, but you can order it separately as an accessory. Vacuum outlets are supplied in set only.

i ORDER CODE:
DSE 73-730YY-73XXXX

* Until stocks are sold out.



elegant

medical



Colour outlets are used to clearly resolve circuits with different types of back-up power supply (distributions for healthcare, data and computer networks, etc.). ELEGANT Medical line can be combined with other ELEGANT switches and outlets for a complex wiring solution within given building.

colour coding of socket outlets



snow white frame / cover green medical

green - critical circuit

Green outlet cover plates are used for connecting equipment which must have restored provision of emergency power from the main emergency source (usually a diesel generator with auto-start) within at most 2 minutes of a power failure from the primary source. This emergency source supplies electricity for the entire duration of the interruption of the primary source.



snow white frame / cover yellow medical

yellow - medical isolated circuit

Yellow outlet cover plates are used exclusively for connecting medical equipment essential for sustaining the life and health of patients. The nature of use of this equipment means that its power cannot be interrupted in the event of a fault within the circuit. A medical isolated power system therefore allows operation to continue even in such situations, while the circuit failure is visually and acoustically signalled. Since a further failure could then lead to interruption of system power, it is vital to repair the failure immediately after finishing the ongoing operation. Medical isolated power system is powered from critical circuits. This means that emergency power from the main back-up source is secured within 2 minutes.



snow white frame / cover orange medical

orange - highly critical circuit

Orange outlet cover plates are designated for power outlets of highly critical circuits whose power may not be interrupted for more than 15 seconds. This will principally involve a medical isolated power system with an even higher level of provision of emergency electrical power supply, because the primary winding of its protective isolation transformer is fed from the UPS, almost always operated in on-line mode (without interruption of the power supply to connected equipment). As the emergency source will have a limited output and operating time, this type of outlet may only be used to supply medical equipment which supports or substitutes basic life functions, which does not have emergency power provided by other means, and for which the power recovery time of the main emergency source is too long.



snow white frame / cover snow white

white - less critical circuit

White outlet cover plates are designated for connecting routine equipment and appliances (cookers, refrigerators, coffee machines, cleaning equipment etc.). Medical equipment can be connected to these circuits only in exceptional, emergency situations, when there is no power in the other outlets (green, yellow or orange).



snow white frame / cover signal brown

brown - less critical circuit

Brown cover plates designate outlets of less critical circuits with their protection increased by residual-current devices. They are designated for medical and non-medical equipment where increased protection against electric shock is appropriate or necessary. A connection to a less critical circuit with a residual-current device is designated by the letter code MF.



snow white frame / cover red medical

red - less critical circuit

Red cover plates are recommended for outlets designated for connecting computers and their accessories into circuits with their own UPS.

sets



single elegant medical outlet (2P+PE)



single elegant medical outlet with safety shutters (2P+PE)



single elegant medical outlet with safety shutters and overvoltage protection (2P+PE) LIGHT INDICATION



double elegant medical outlet 2x (2P+PE)



double elegant medical outlet with safety shutters 2x (2P+PE)



double elegant medical outlet with safety shutters and overvoltage protection 2x (2P+PE) LIGHT INDICATION



single outlet with operational status indicator



terminal for equalizing potential (socket for protective bonding)

covers



single outlet cover 2P+PE
DSE 00-890YY-000000



double outlet cover 2x (2P+PE)
DSE 00-820YY-000000



single outlet cover with overvoltage protection 2P+PE
DSE 00-840YY-000000



double outlet cover with overvoltage protection 2P+PE
DSE 00-850YY-000000

medical cover colours



14 orange medical



15 yellow medical



16 green medical



17 red medical



10 signal brown



01 snow white



Colour tones may differ slightly from reality.



ORDER CODE:
DSE 00-YYYY-000101



thermostats and motion sensors

retro, decente,
elegant design



Various thermostats and motion sensors can be aligned in the same design as the rest of switches and outlets. Motion sensors automatically switch most often lighting and are useful mainly in the premises with frequent movement of people. Thermostats observe room temperature and optimally regulate heating, some allow you to set different time scenarios. Choose reliable devices from a wide range of materials and colours among our RETRO, DECENTE or ELEGANT products.



EBERLE

thermostats



PRODUCT	THERMOSTAT RTR-E 8011-50	THERMOSTAT FRE L2A-50 LIMITER	THERMOSTAT FIT 3U	THERMOSTAT FIT 3U	THERMOSTAT FIT 3U
order code	DSE 2T, DSD 2T*, DSR 2T	DSE 3T, DSD 3T*, DSR 3T	DSE 4T, DSD 4T*, DSR 4T	DSE 4T, DSD 4T*, DSR 4T	DSE 4T, DSD 4T*, DSR 4T
description	analogue thermostat under plaster mounting ROOM (modular 50x50)	analogue thermostat under plaster mounting FLOOR (modular 50x50) with sensor	digital thermostat under plaster mounting ROOM (modular 50x50)	digital thermostat under plaster mounting FLOOR** (modular 50x50)	digital thermostat under plaster mounting COMBINED (modular 50x50)
dimensions (h×w×d)	84×89×42 mm	84×89×42 mm	84×89×42.5 mm	84×89×42.5 mm	84×89×42.5 mm
temperature range	10–40 °C	10–40 °C	5–30 °C	10–40 °C	10–40 °C room a 10–40 °C floor
contact (relay)	switching (AC 230 V)	switching (AC 230 V)	switching (AC 230 V)	switching (AC 230 V)	switching (AC 230 V)
working voltage	AC 230 V 50 Hz	AC 230 V 50 Hz	AC 230 V 50 / 60 Hz	AC 230 V 50 / 60 Hz	AC 230 V 50 / 60 Hz
switching current	10 (4) A	10 (4) A	10 mA–10 (4) A	10 mA–16 (4) A	10 mA–10 (4) A
hysteresis	cca 1 K	cca 1 K	in steps of 0.1°C	in steps of 0.1°	in steps of 0.1°
regulation	ON/OFF	ON/OFF	PWM or ON/OFF	PWM or ON/OFF	PWM or ON/OFF
protection	IP 30	IP 30	IP 30	IP 30	IP 30

i * If you order an ELEGANT frame, order the device with code DSE XX. If device is used with DECENTE design, proceed with code DSD XX. If device is used with RETRO design, proceed with code DSR XX.
** Floor sensor is sold separately as DSE 56.



PRODUCT	FLOOR SENSOR
order code	DSE 56
description	floor sensor for EBERLE thermostats
dimensions (h×w×d)	4 m
temperature range	0–70 °C

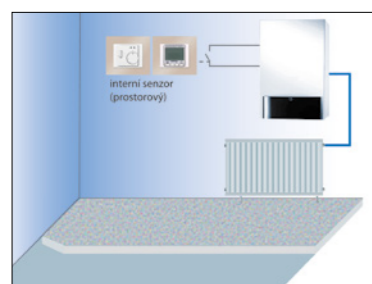

ROOM THERMOSTATS
Allow measurement of room temperature using an intergrated room sensor and regulation (swit-ching) of e.g. central heating boilers (potential-free contact).

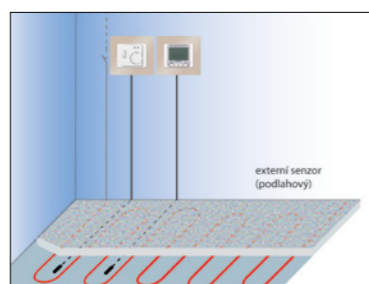

FLOOR THERMOSTATS
Used mainly for controlling the temperature of underfloor heating using an external sensor. Can also be used for sensing and regulation in other media (tubes, liquids, solid and loose materials etc.).

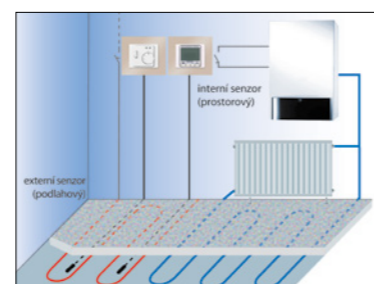

COMBINED THERMOSTATS
Temperature can thus be regulated using an internal or external sensor. Used with e.g. underfloor heating, where room sensor works as the main sensor and floor sensor as protection against overheating.



PRODUCT	PIR SENSOR 180-R	PIR SENSOR 180-T	PIR SENSOR 180-R-2D	PIR SENSOR 180-TR
order code	DSE B1 / DSD B1' / DSR B1 - B1001	DSE B2 / DSD B2' / DSR B2 - B1001	DSE B3 / DSD B3' / DSR B3 - B1001	DSE B4 / DSD B4' / DSR B4 - B1001
description	Wall-mounted motion detector with acoustic sensor. Relay version in three-wire technology. Automatic extension of transition time through sounds. Possible manual button control.	Wall-mounted motion detector with acoustic sensor. Triac design with 2-wire technology, without zero conductor. Only for ohmic loads. Automatic extension of transition time through sounds.	Wall-mounted motion detector with acoustic sensor. Relay design with 2-wire technology thanks to built-in battery. Automatic extension of transition time through sounds.	Wall-mounted motion detector designed for switching staircase automatic lights. Triac design with 2-wire without zero-conductor. It guarantees perfect operation with LUXOMAT® SCTI (up to 10 detectors per device).
dimensions (h×w×d)	mounting depth 36 mm	mounting depth 36 mm	mounting depth 36 mm	mounting depth 36 mm
power	2 300 W, cos φ = 1 1 150 W, cos φ = 0,5	300 W / min. 40 W cos φ = 1 not suitable for LED	2 300 W cos φ = 1 not suitable for LED	max. 200 mA / 230 V
voltage	110–240 V AC 50 / 60 Hz	110–240 V AC 50 / 60 Hz	110–240 V AC 50 / 60 Hz 5× NiMH / 30 AAAA, 1.2 V / 200 mA	110–240 V AC , 50 / 60 Hz operation via a staircase automat (230 V)
coverage angle	180° vertically	180° vertically	180° vertically	180° vertically
range	max. 10 m	max. 10 m	max. 10 m	max. 10 m
twilight setting	2–2 000 lux	2–2 000 lux	2–2 000 lux	2–2 000 lux
time setting	15 s – 16 min nor bell impulse	15 s – 16 min nor bell impulse	15 s – 16 min nor bell impulse	impulse duration 0.1 s
protection	IP 20 / class II	IP 20 / class II	IP 20 / class II	IP 20 / class II

PRODUCT	PIR SENSOR 180 M 2C	PIR SENSOR 180 S	PIR SENSOR 180-R-11-48V	PIR SENSOR 180-KNX
order code	DSE B5 / DSD B5' / DSR B5 - B1001	DSE B6 / DSD B6' / DSR B6 - B1001	DSE B7 / DSD B7' / DSR B7 - B1001	DSE B8 / DSD B8' / DSR B8 - B1001
description	Wall-mounted presence detector, master model. Switching channel for switching the light on. Potential-free HVAC contact. Possible extension of detection range with slave devices. Automatic extension of transition time through the sounds.	Wall-mounted presence detector, slave model. To extend the detection range of master model. Compatible with all master devices except: PD4-M- DS-FC, 11-48V devices, PD9-M- SDB.	Wall-mounted motion detector with acoustic sensor with operating voltage 11–48 V. Potential-free switching contact. Possible manual button control.	Wall-mounted presence detector KNX with acoustic sensor and integrated BUS connector. When using B.E.G._Occupancy detector_928XX_V5.0, several operating modes are available:
dimensions (h×w×d)	mounting depth 36 mm	mounting depth 36 mm	mounting depth 36 mm	mounting depth 36 mm
power	channel 1 (lighting check): 2 300 W, cos φ = 1 1 150 VA, cos φ = 0,5 channel 2 (HVAC check): 3 A, 230 V, cos φ = 1	slave	3 A cos φ = 1	KNX
voltage	110–240 V AC 50 / 60 Hz	110–240 V AC 50 / 60 Hz	11–48 V AC / DC	KNX
coverage angle	180° vertically	180° vertically	180° vertically	180° vertically
range	max. 10 m	max. 10 m	max. 10 m	max. 10 m
twilight setting	2–2 000 lx	2–2 000 lx	2–2 000 lx	2–2 000 lx
time setting	channel 1: 15 s – 30 min, impuls channel 2: 5 min – 120 min, impuls, alarm impuls	impuls 2 s or 9 s	impuls 15 s – 30 min	
protection	IP 20 / class II	IP 20 / class II	IP 20 / class II	IP 20 / class II

i * Motion sensors can be implemented into ELEGANT (use DSE XX), DECENTE (use DSD XX) or RETRO design (use DSR XX).

wiring diagrams

switch arrangement 1 (singlepole switch)

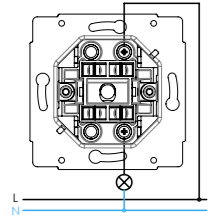

Used to control one device or one device group from one place. For other switches there is only one device in a given switching circuit considered.

switch arrangement 1+1+1

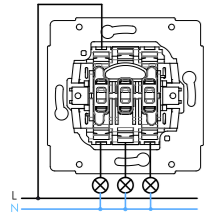

switch arrangement 2 (twopole switch)

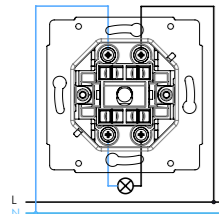

Usually used where it is needed to turn off work and central wire at the same time.

switch arrangement 5 (serial change-over switch, singlepole) two circuit switch with switched-off position)

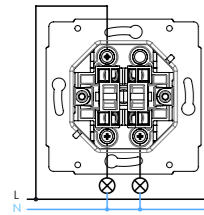

For controlling two electrical circuits from one spot.

single outlet

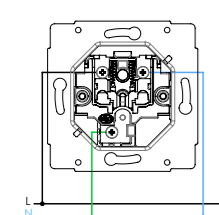

Connects electrical device to electricity grid. Safety outlets are also available: outlet with safety shutters, IP 44 outlet.

double outlet

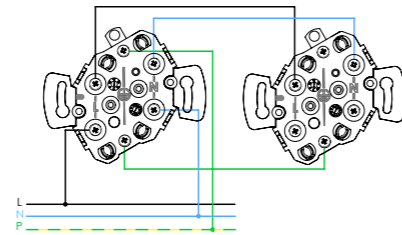

Double outlets connects electrical devices to electricity grid

switch arrangement 6 stair switch (change-over switch), singlepole 2-way switch without switched off position

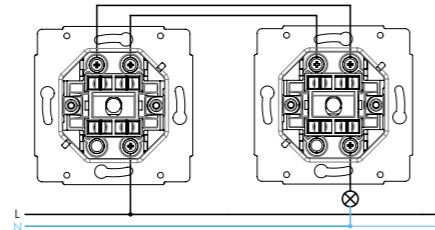

Classic control of staircase or hallway lighting from two spots.

switch arrangement 6+6 double stair switch (serial change-over switch)

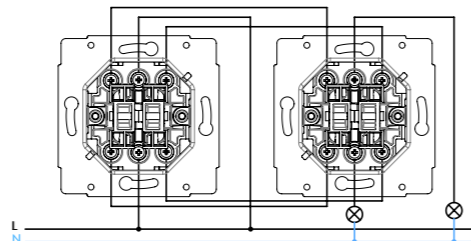

For controlling two electrical circuits from two spots.

switch arrangement 6+7+6 change-over switch - cross-bar switch - change-over switch

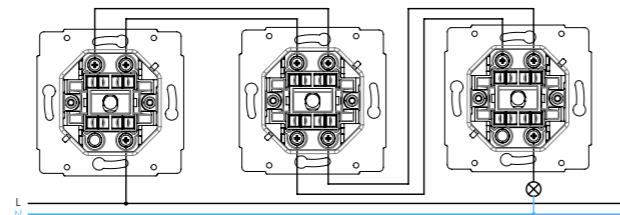

Between two switches 6, any number of switches 7 can be placed.

wiring diagram for retro (cam switch)

arrangement 1

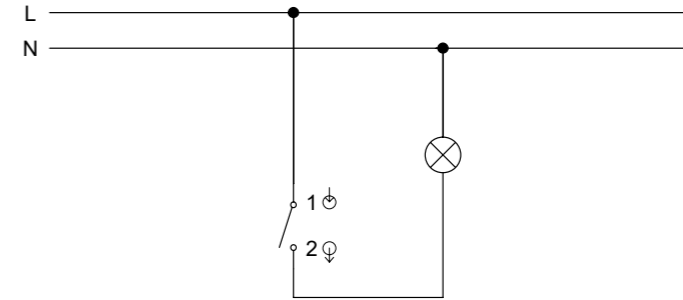

arrangement 2

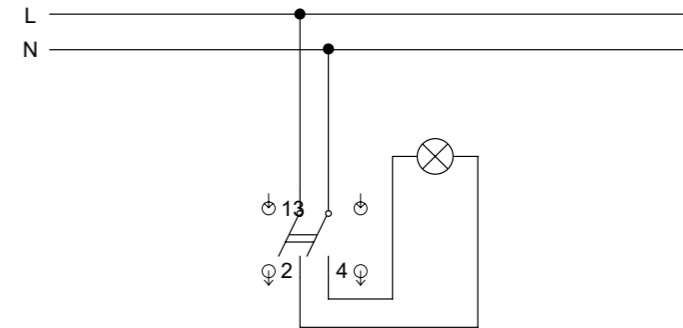

arrangement 5

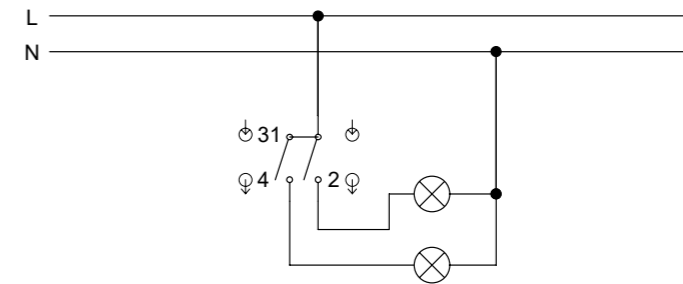

arrangement 6

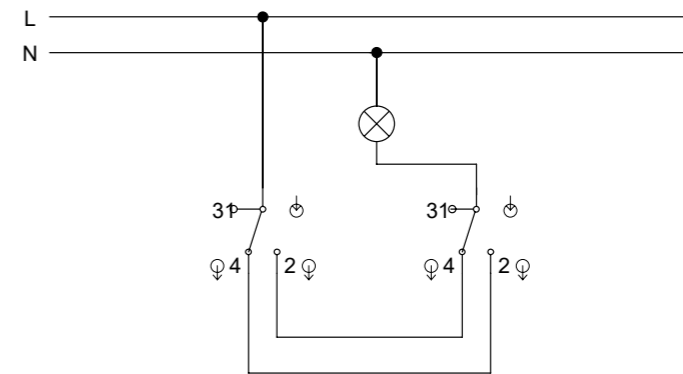

arrangement 6+7+6

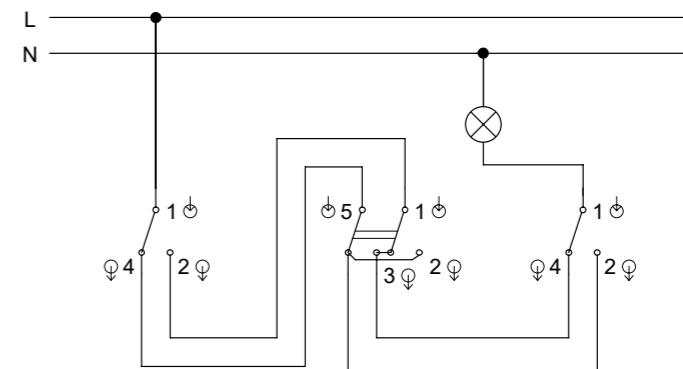

nexa

frames

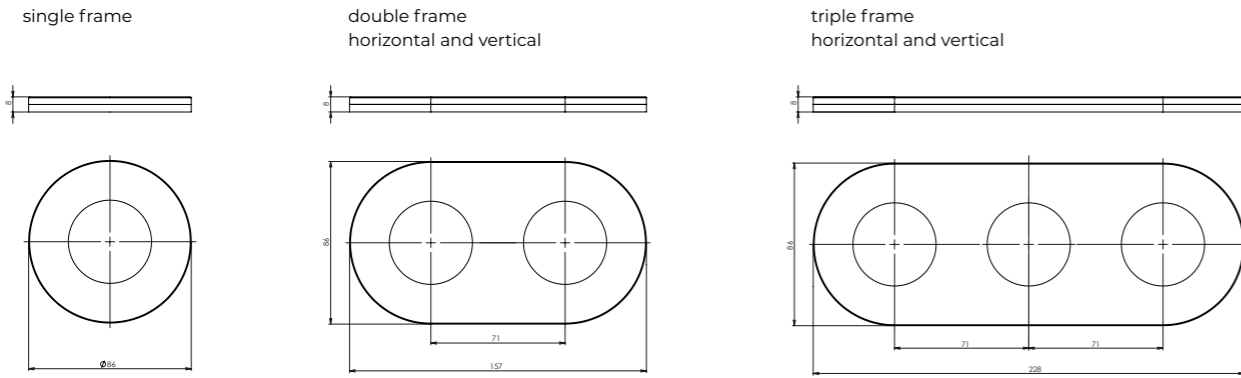

Multiple frames can be installed both horizontally and vertically (are compatible).

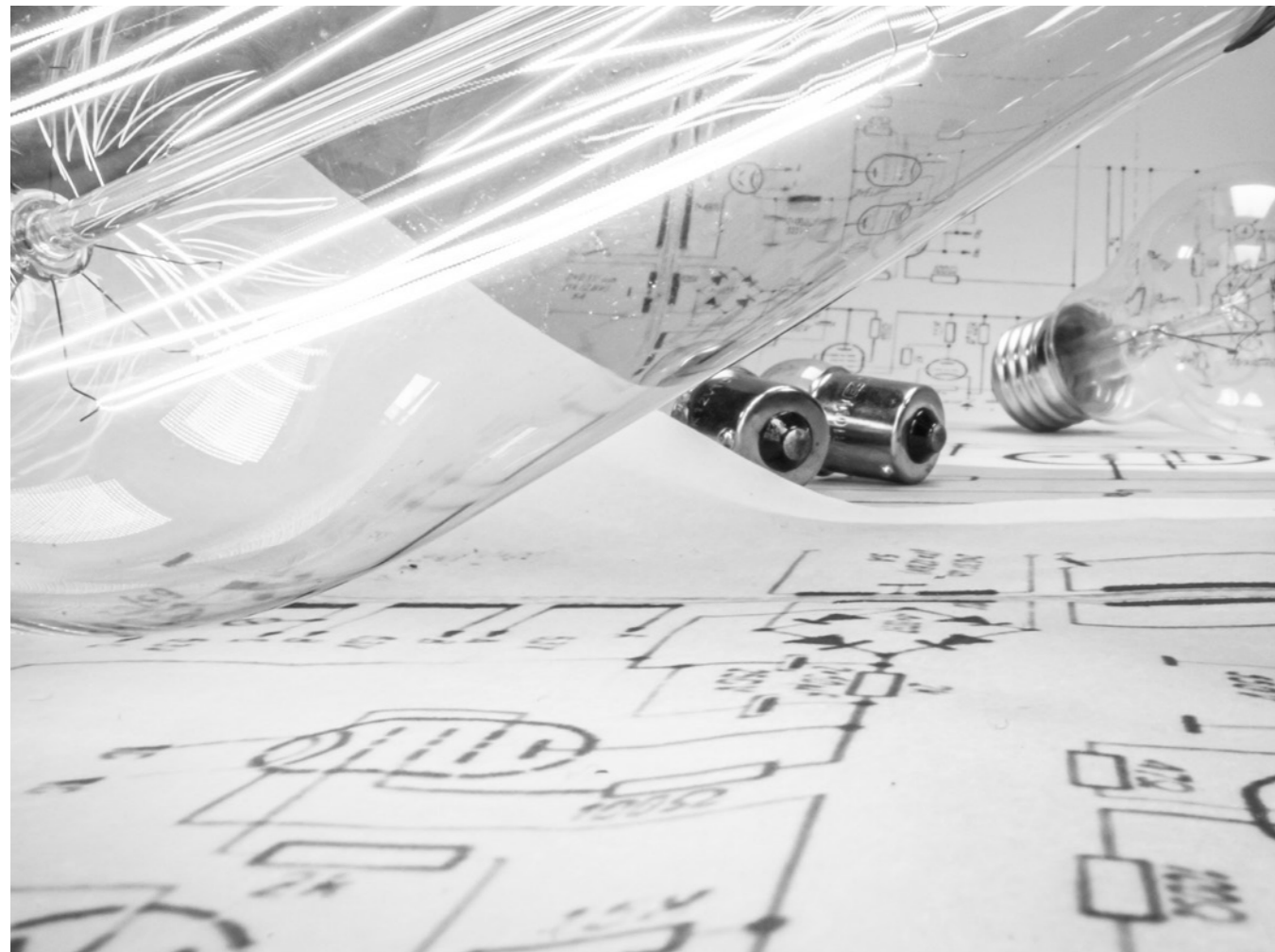

nexa

fittings

house switch arrangement 1, 2, 5, 6

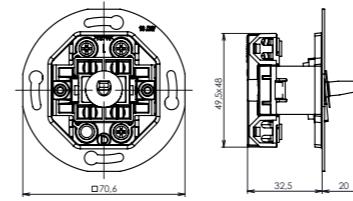

house switch arrangement 5, 6+6, 6/0+6/0

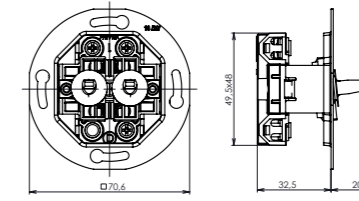

house switch with frame arrangement 1, 2, 6, 7, 1/0

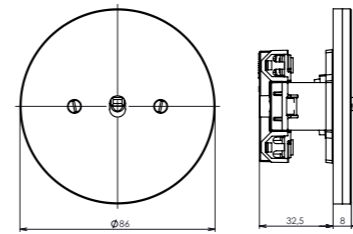

house switch with frame arrangement 5, 6+6, 6/0+6/0

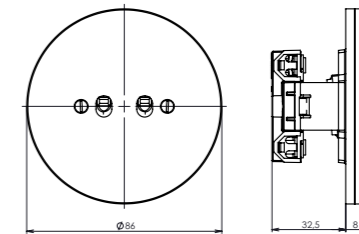

single outlet

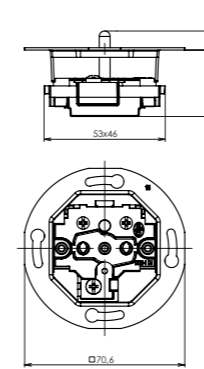

single outlet with frame

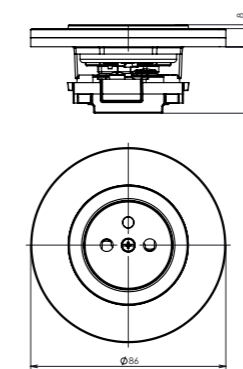

schuko single outlet

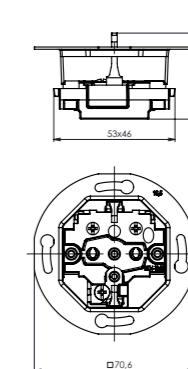

schuko single outlet with frame

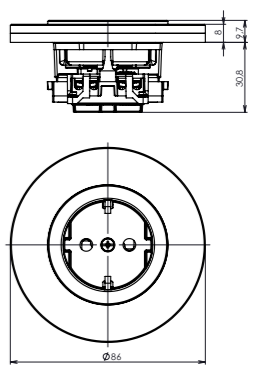

hdmi, usb, tv, sat, pc, rj 45 outlet + outlet charging

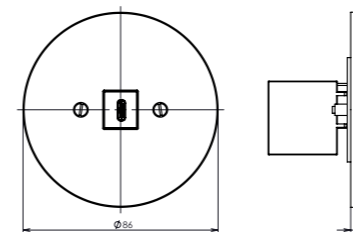

retro

frames

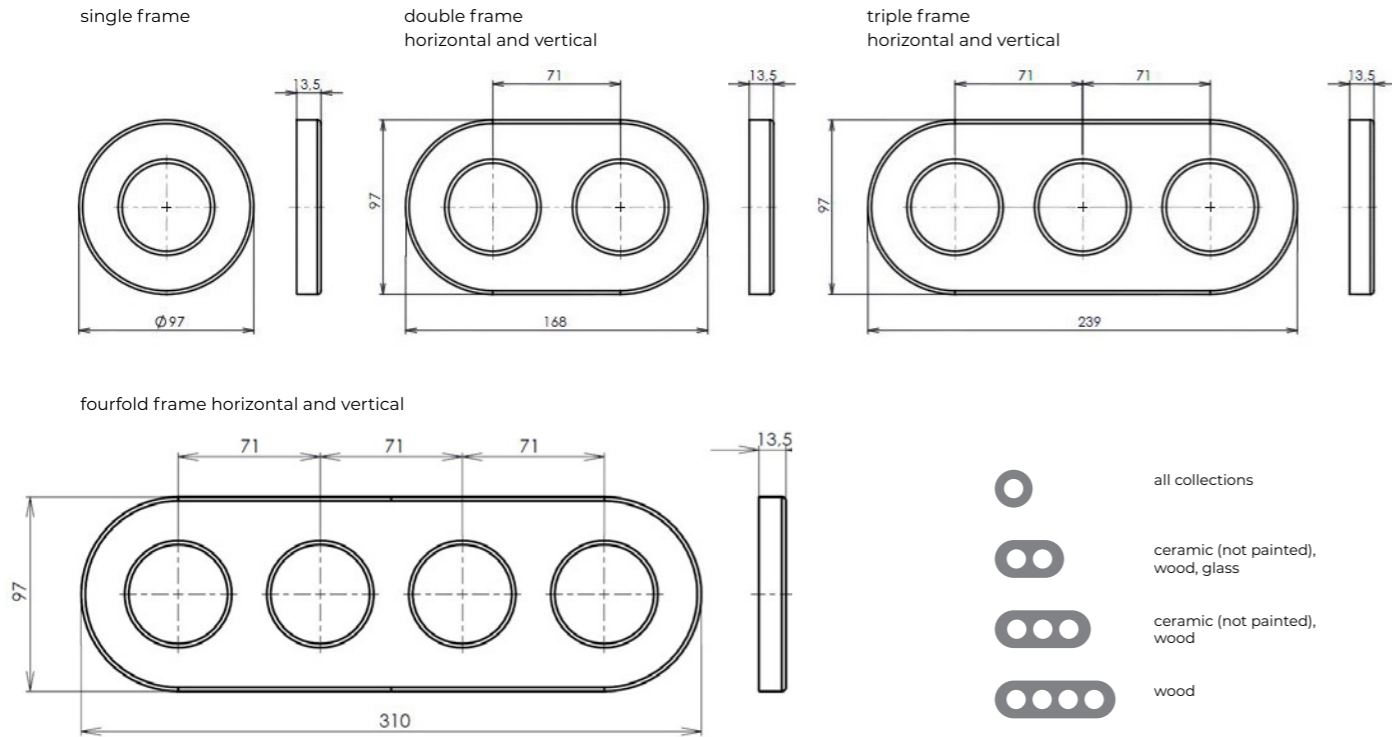

i Multiple frames can be installed both horizontally and vertically (are compatible).

frames for glass collection

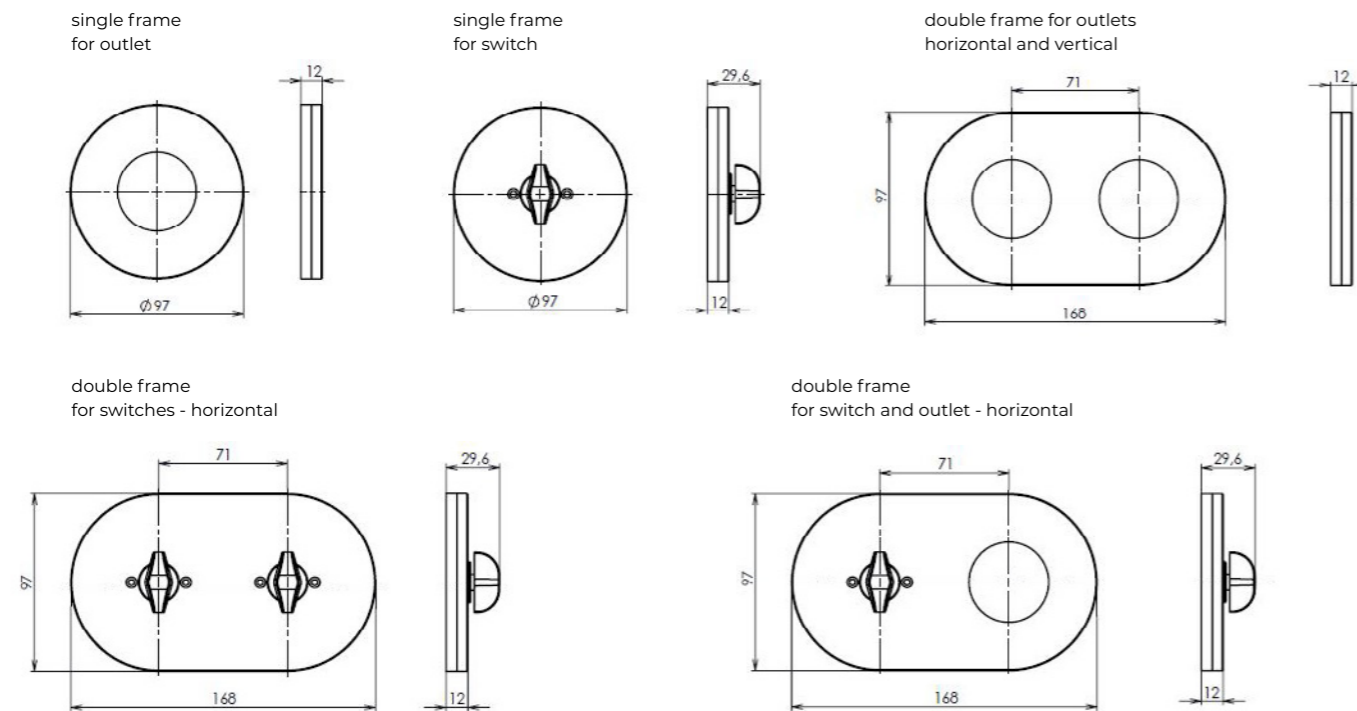

retro

fittings

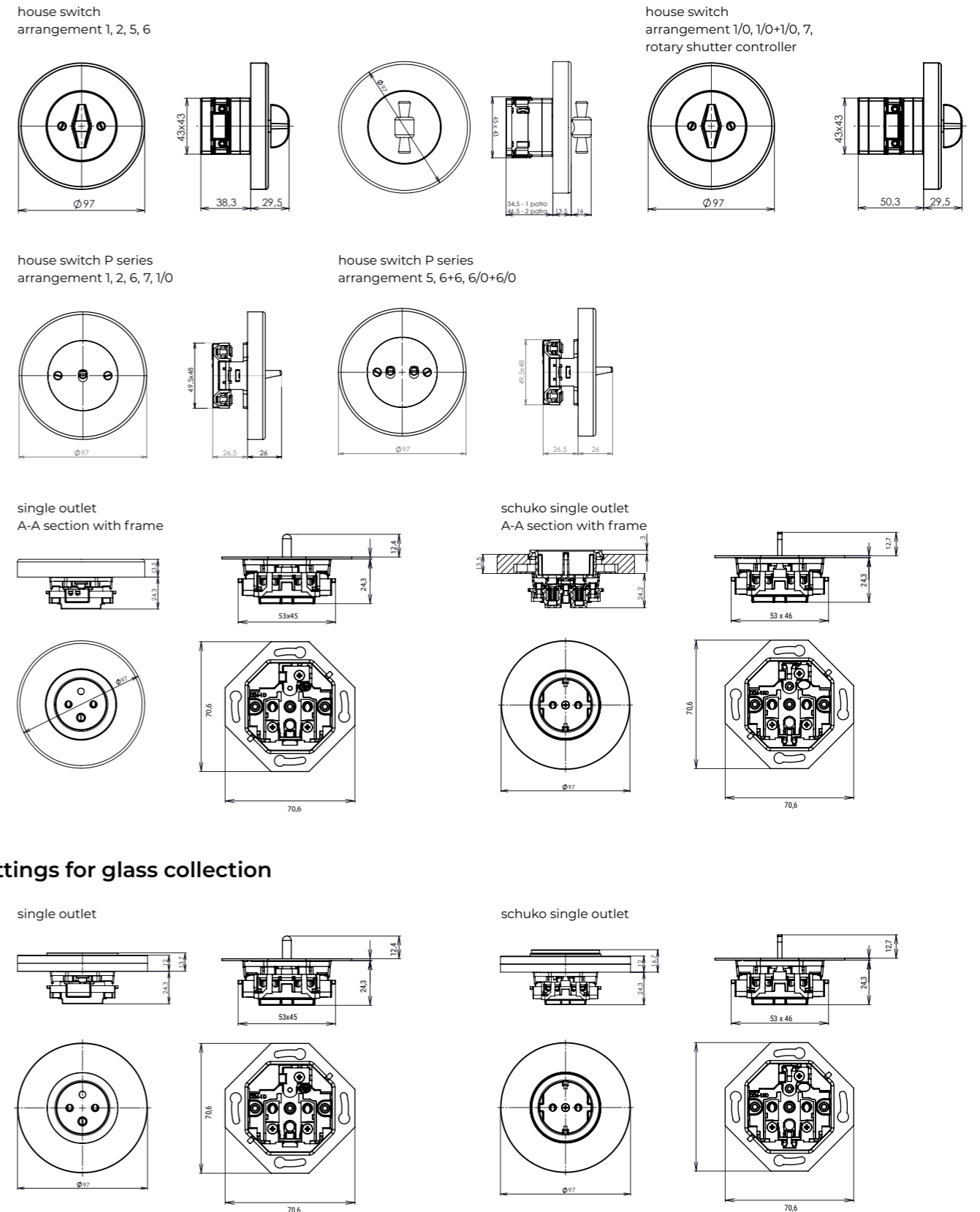

fittings for glass collection

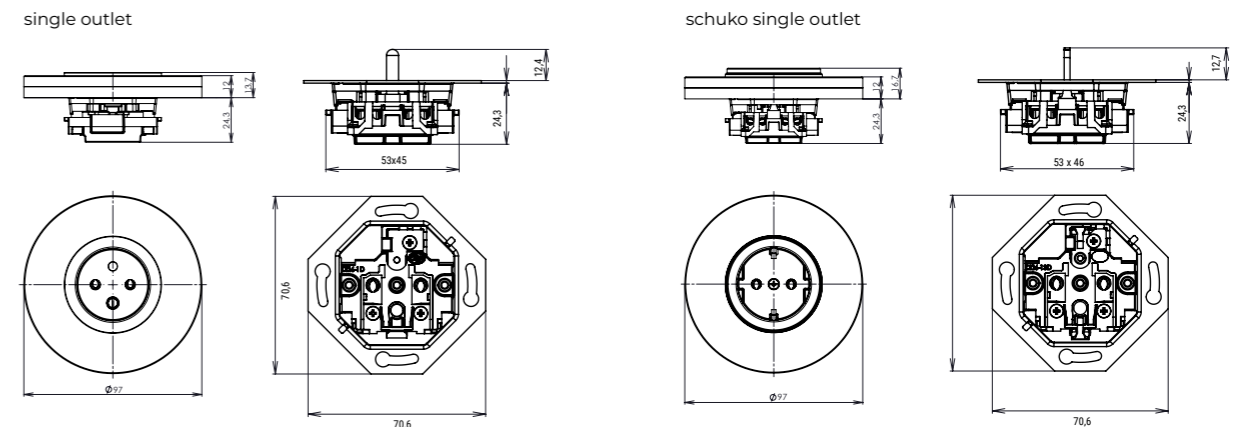

retro

fittings

HDMI, USB,TV,SAT outlet

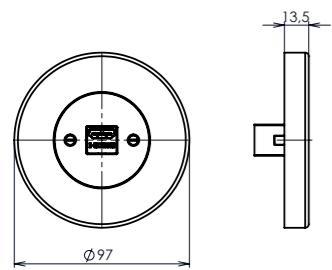

PC, RJ 45 outlet

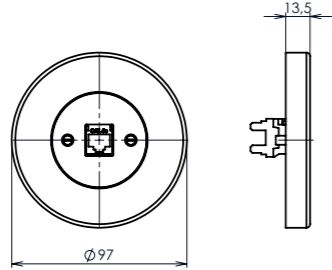

outlet with USB-A charging

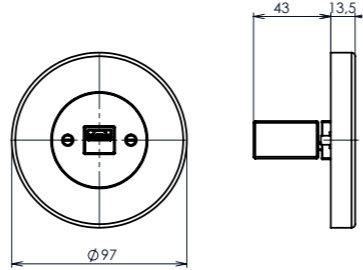

HDMI, USB,TV,SAT outlet glass

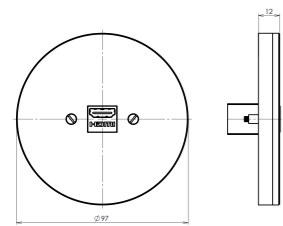

PC, RJ 45 outlet glass

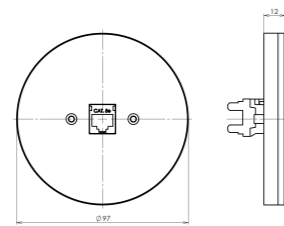

outlet with USB-A charging glass

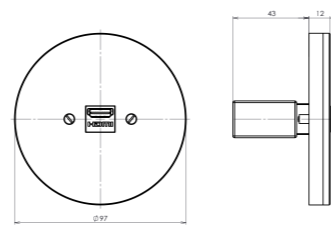

motion sensor B.E.G. glass, wood

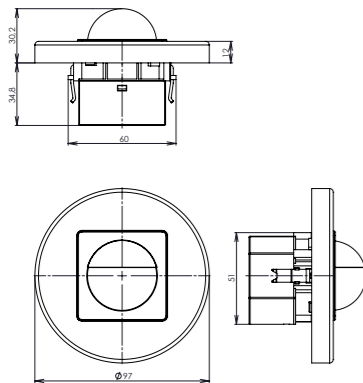

one level cam switch

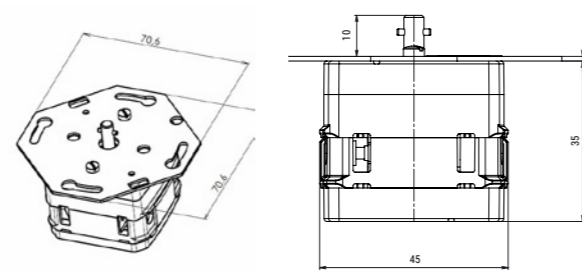

two level cam switch

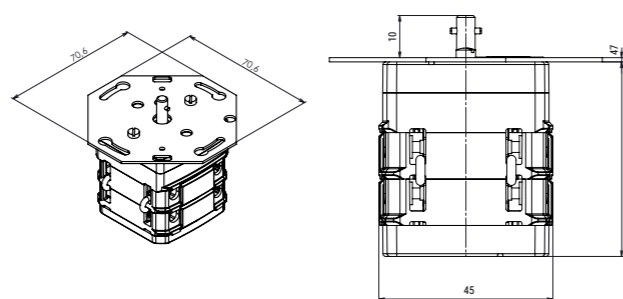

decente

frames

single frame

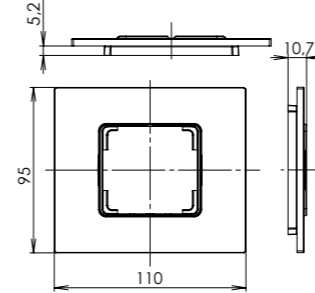

double frame horizontal

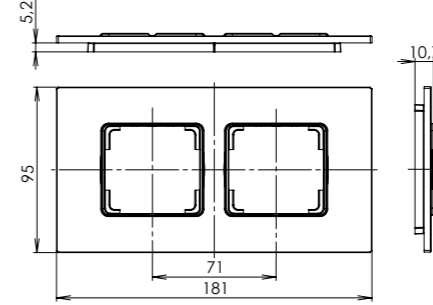

triple frame horizontal

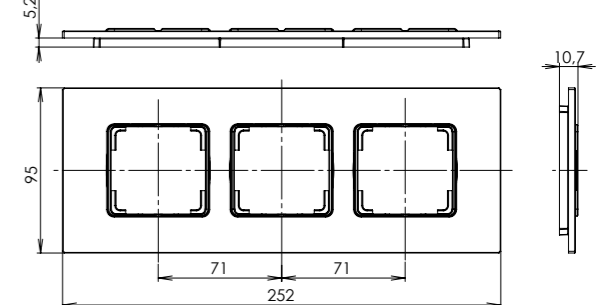

fourfold frame horizontal

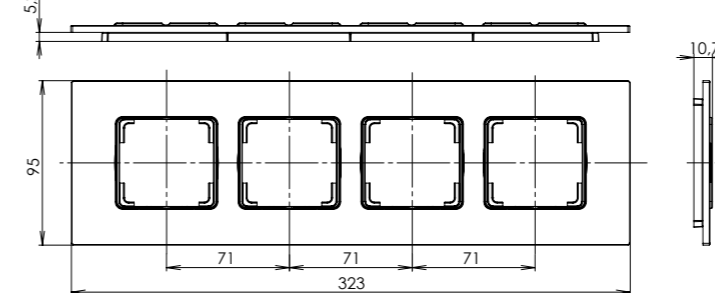

double outlet frame

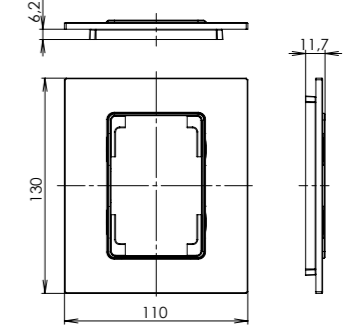

fivefold frame horizontal

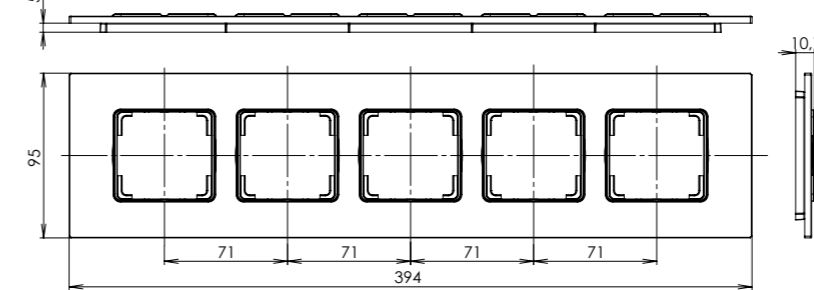

fivefold frame vertical

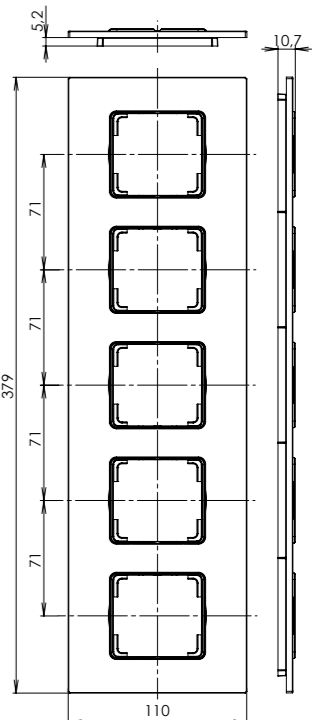

double frame vertical

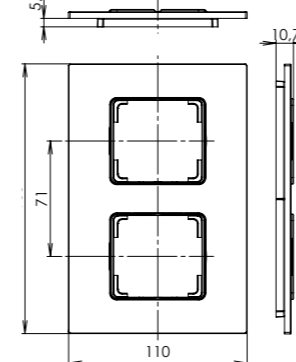

triple frame vertical

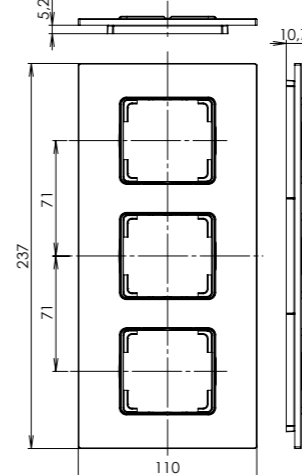

fourfold frame vertical

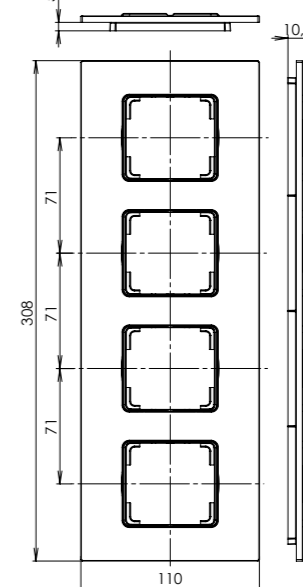

decente

fixtures

switch with single cover

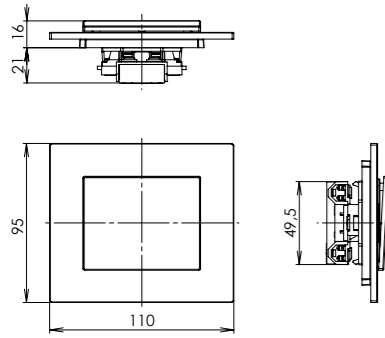

switch with single cover with backlighting

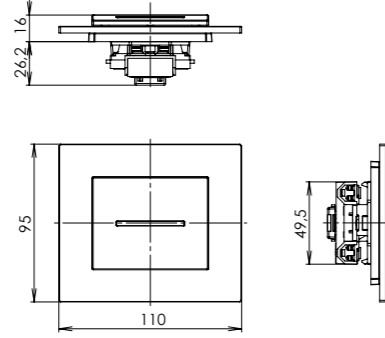

switch with double cover

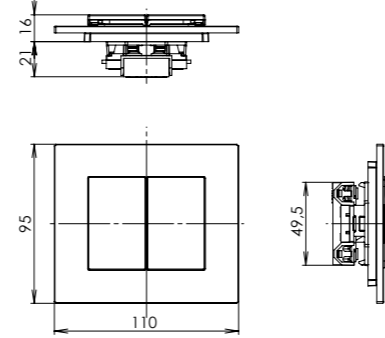

single outlet with safety shutters

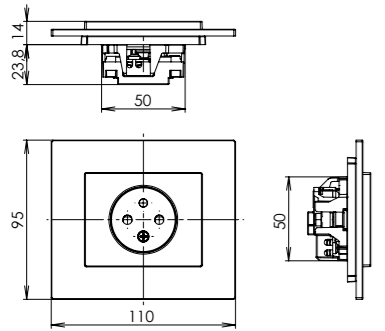

single outlet with safety shutters and overvoltage protection (light indication)

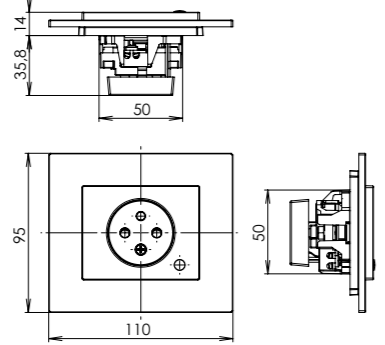

single outlet with safety shutters and overvoltage protection (audible alarm)

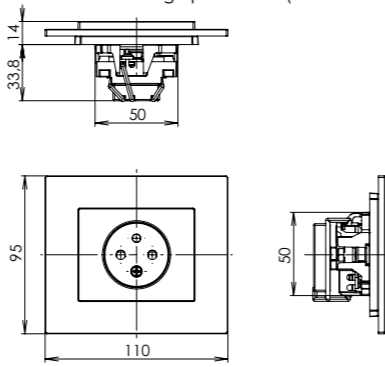

schuko single outlet with safety shutters

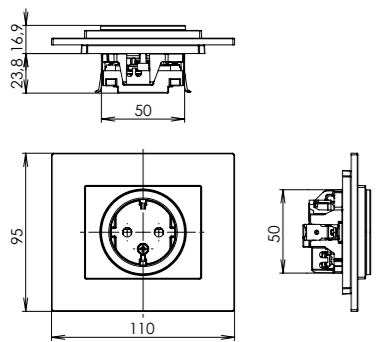

single outlet with safety shutters and overvoltage protection (light indication and audible alarm)

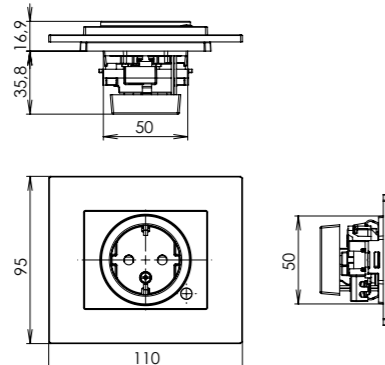

fixtures for glass collection

single outlet with safety shutters

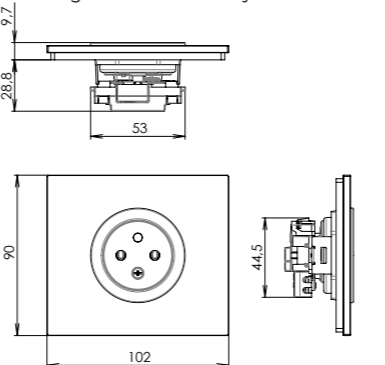

decente

fixtures

double outlet with safety shutters

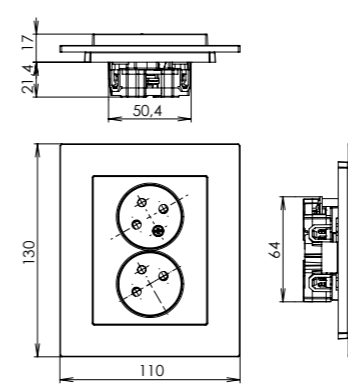

double outlet with safety shutters and overvoltage protection (audible alarm or light indication)

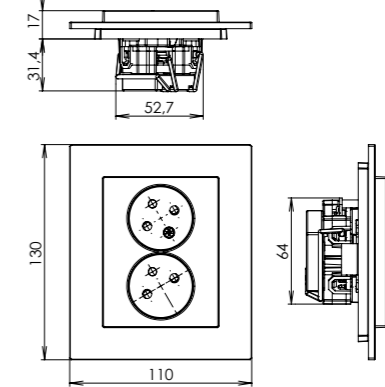

modular outlet USB with charger

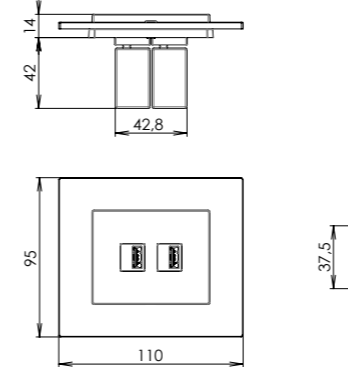

modular data outlet HDMI, USB, RJ45

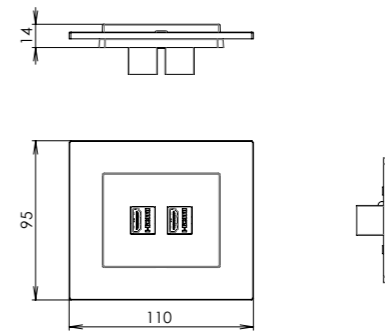

decente

fixtures

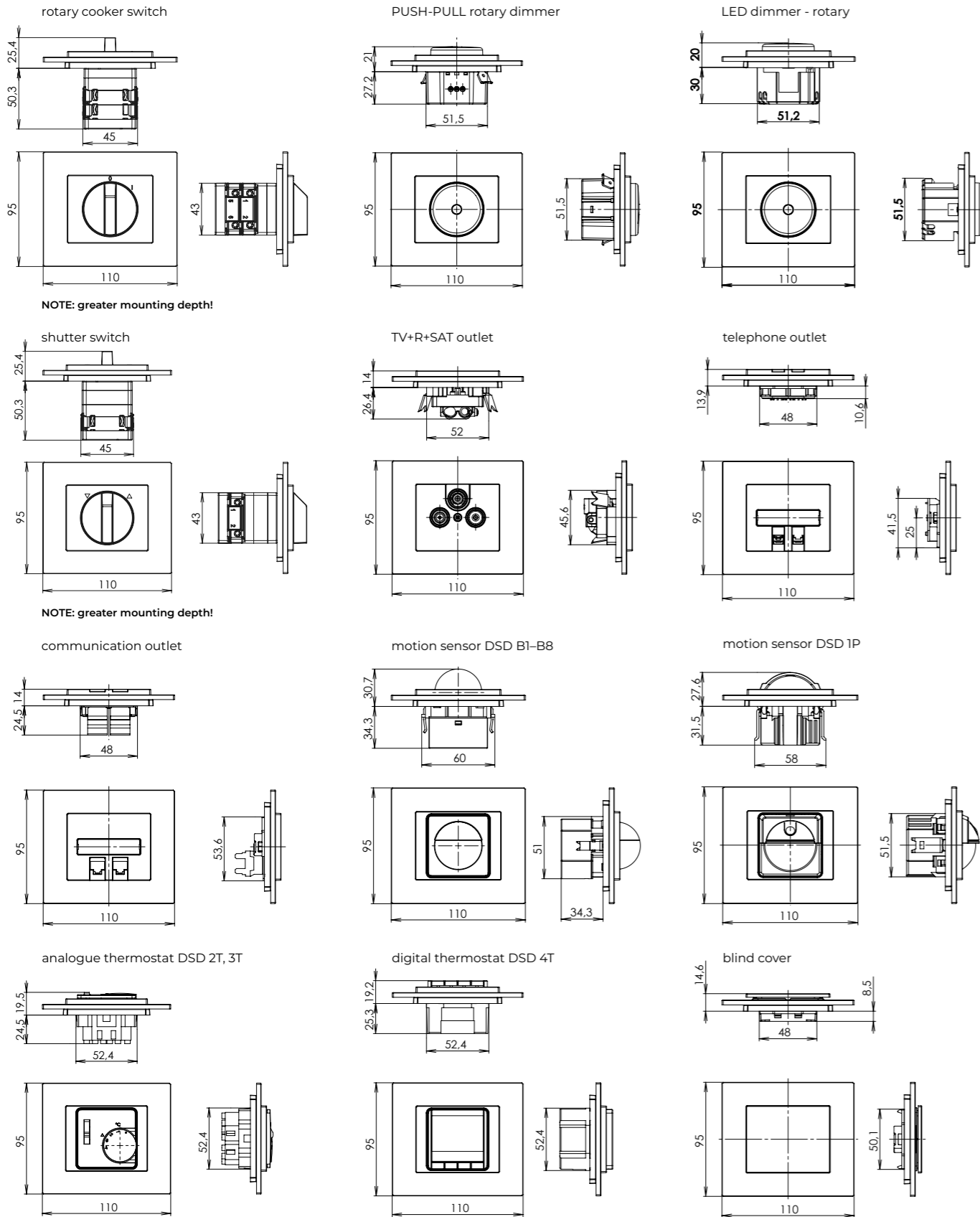

elegant

frames

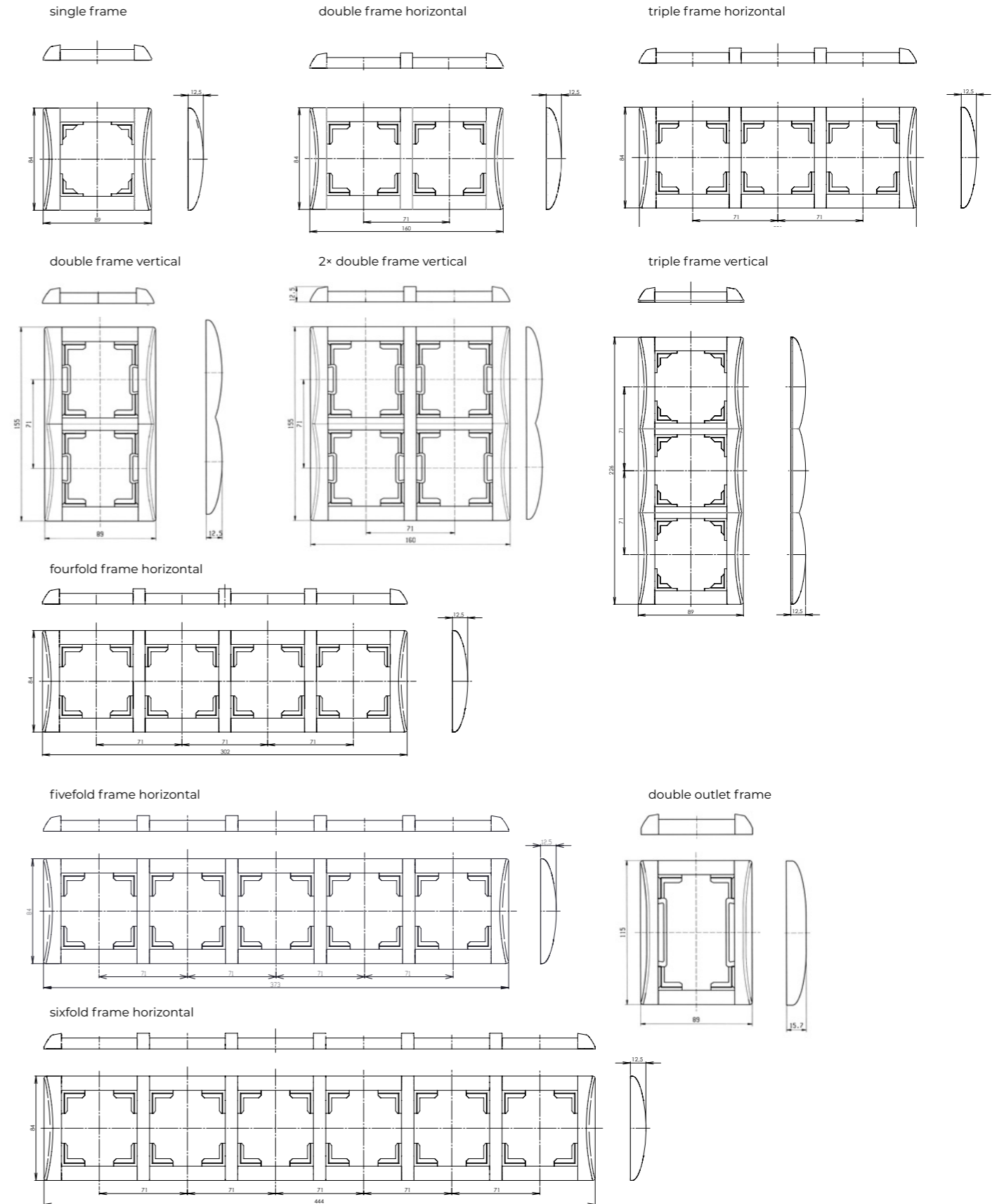

elegant

fittings

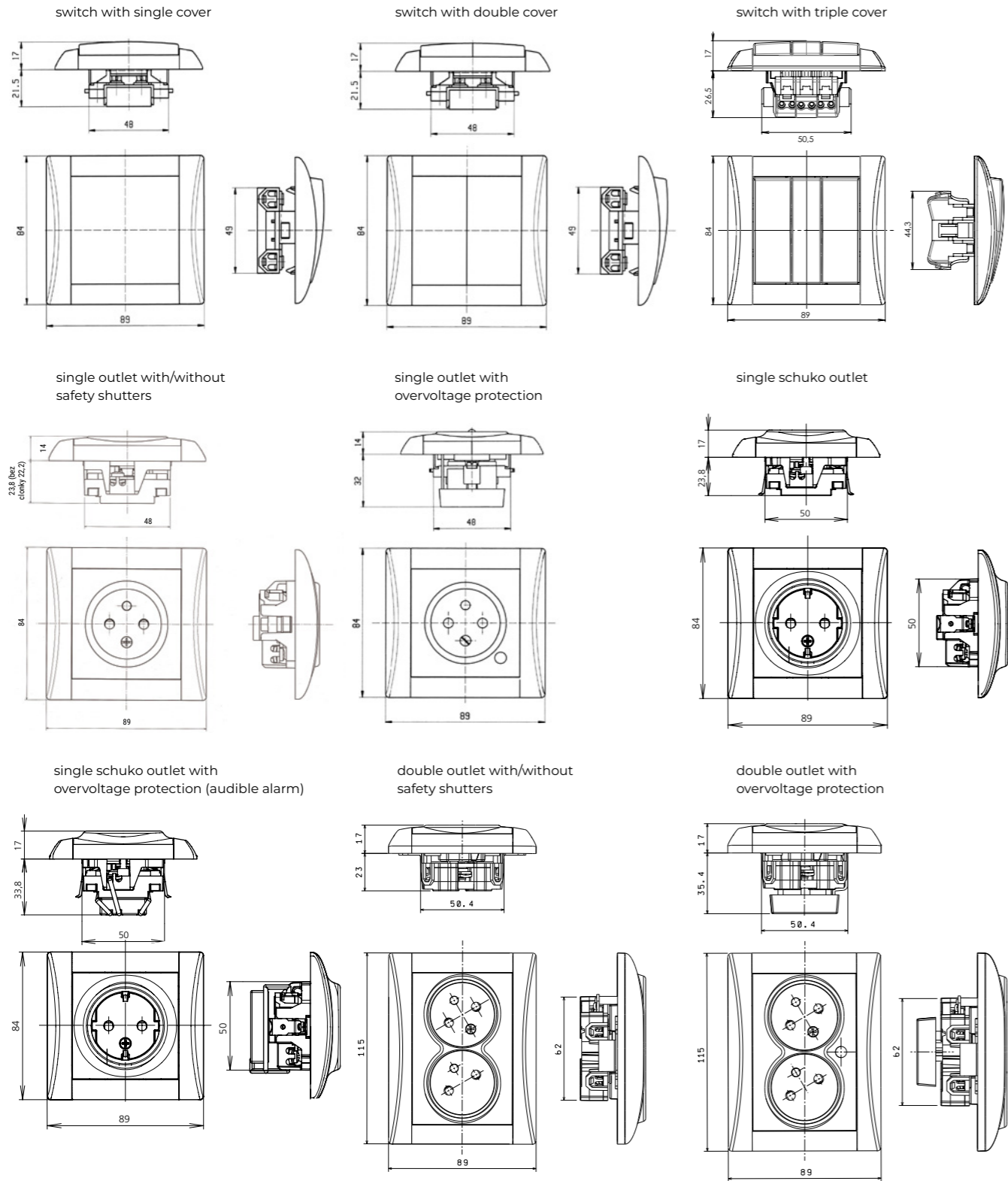

Double sockets must be installed in electrical installation no spout box at 6 and 12 o'clock.

elegant

fittings

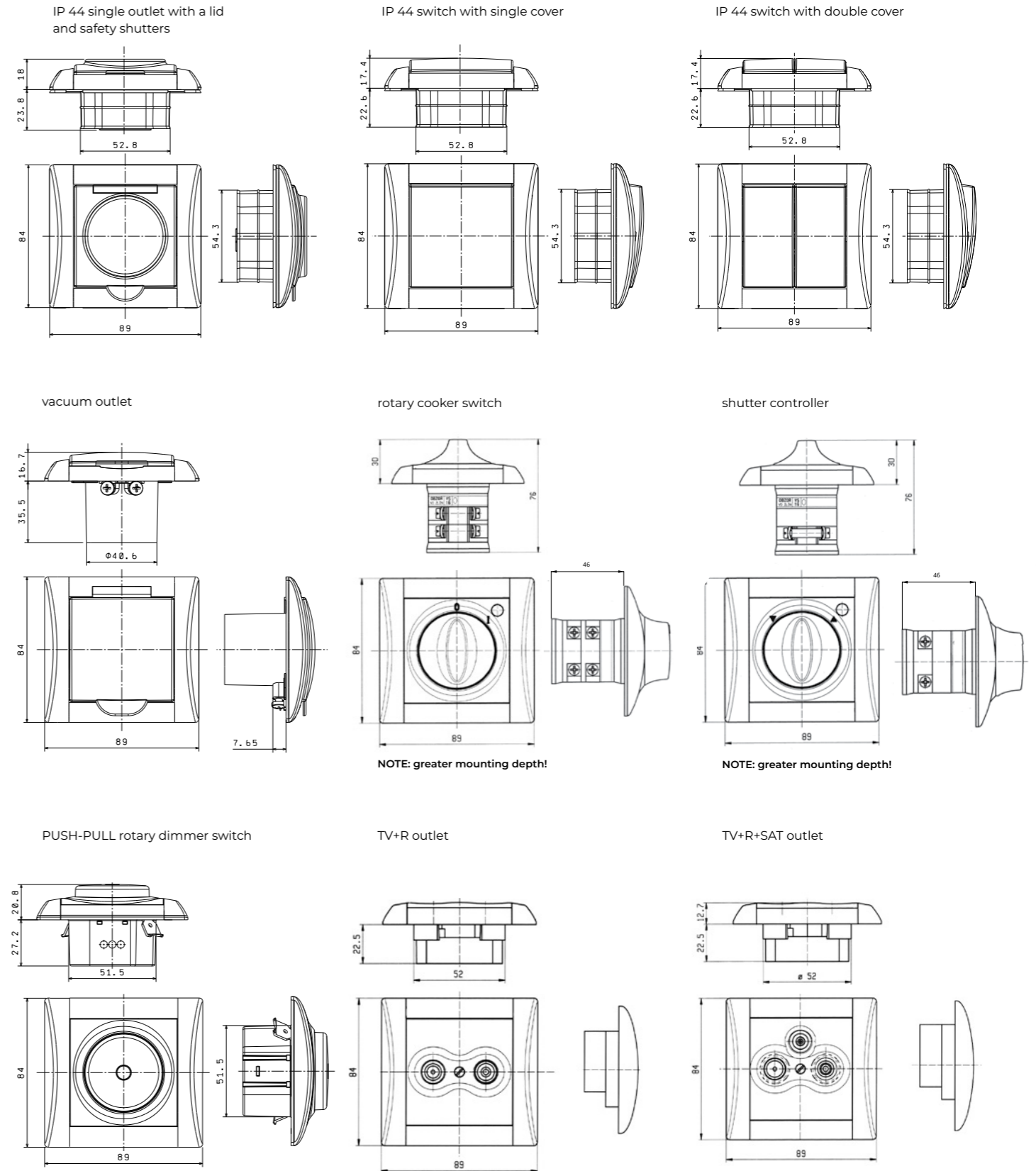

NOTE: greater mounting depth!

NOTE: greater mounting depth!

elegant

fittings

AUDIO-VIDEO outlet

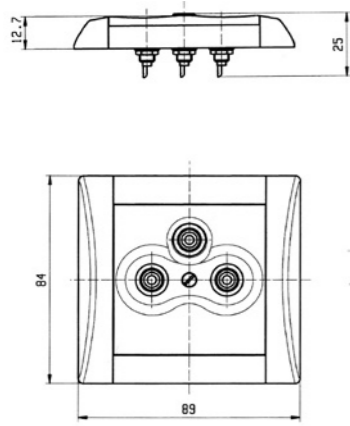

telephone outlet

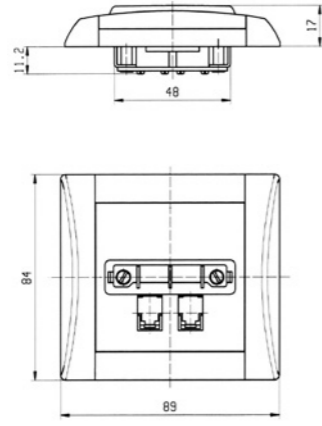

communication outlet

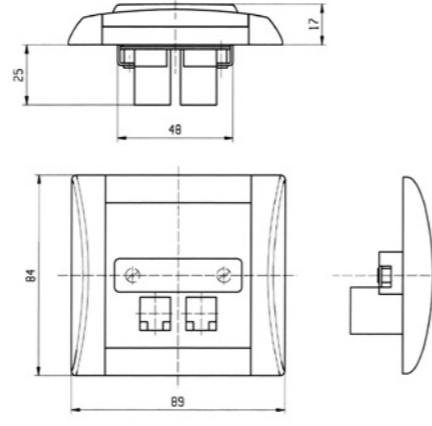

protective bonding outlet

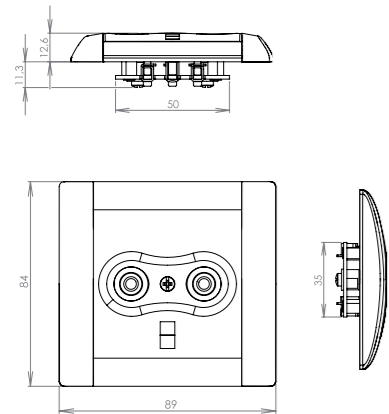

analog thermostat
OREG/EBERLE DSE 2T/3T

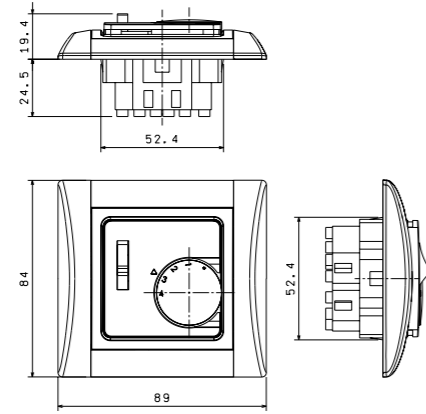

digital thermostat DSE 4T

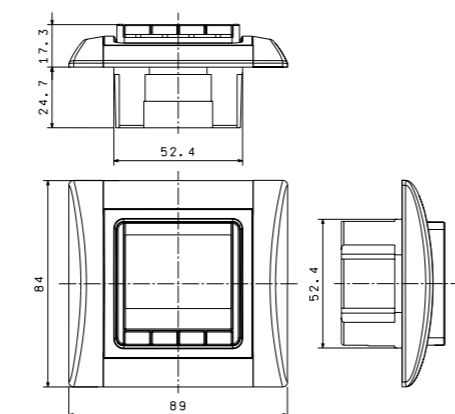

motion sensor STEINEL

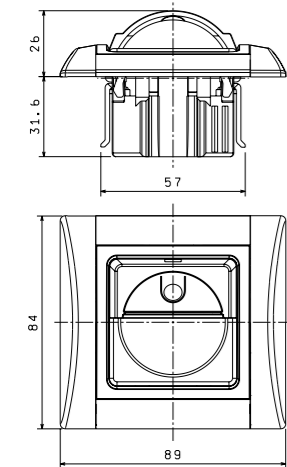

motion sensor B.E.G.

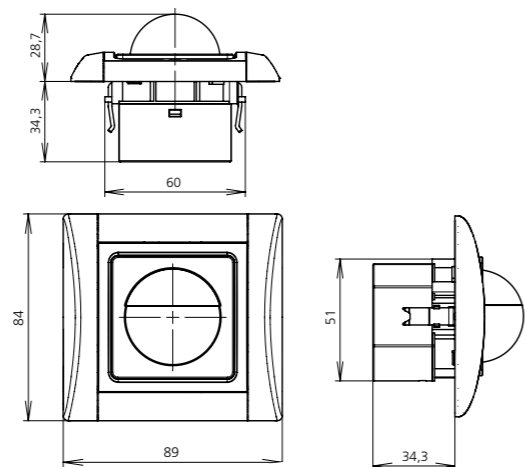

elegant

fittings

spacer ring VK1

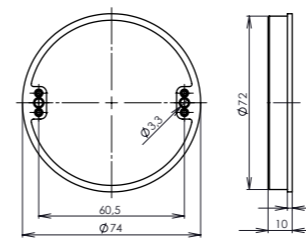

spacer ring VK2

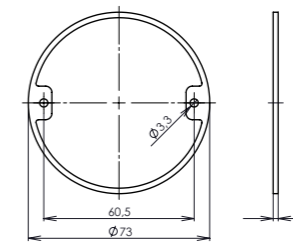

installation box, on-plaster

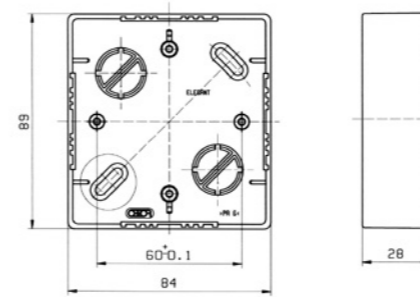

double outlet installation box,
on-plaster

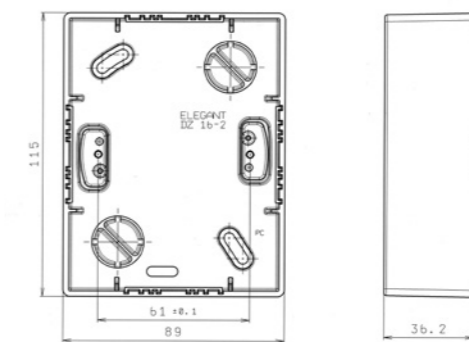

OBZOR



ESHOP

issue 07/2024, subject to change

OBZOR Zlín
Na Slanici 378
763 02 Zlín
Czech Republic

+420 577 195 138
+420 734 258 046
export@obzor.cz

obzorzlin.com
domovnivypinace.cz/en

